

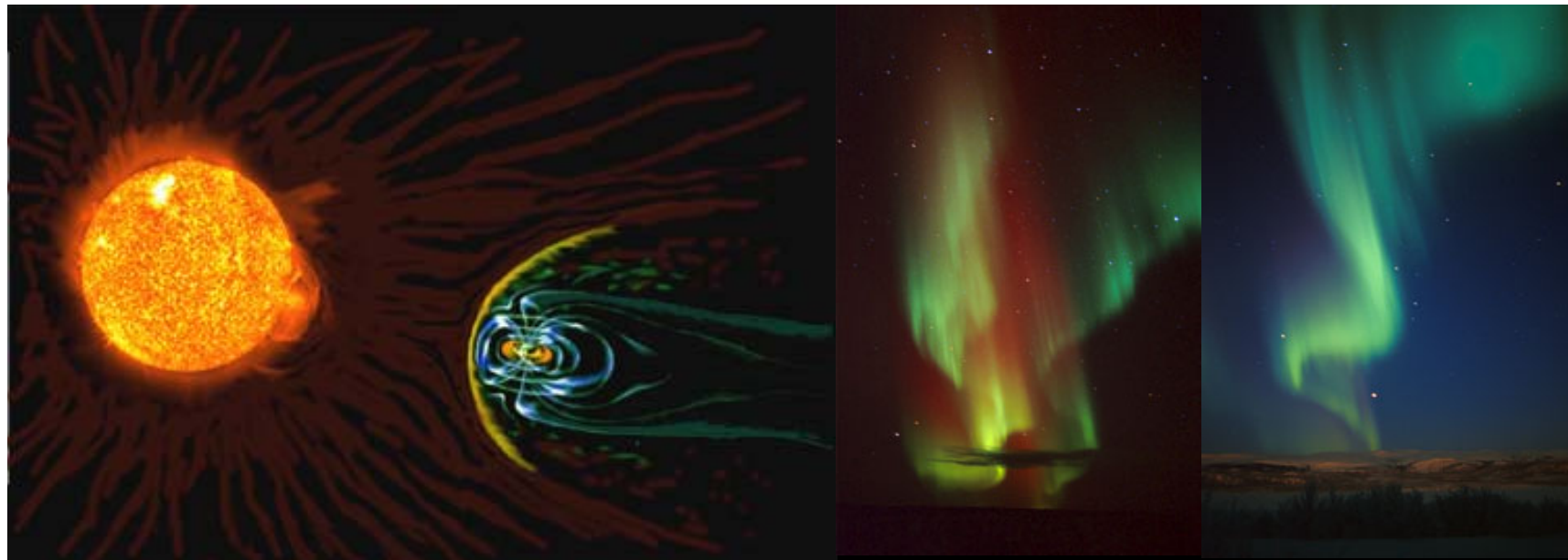

UNIVERSITETET
I OSLO

Ground-based optical auroral measurements

FYS 3610





UNIVERSITETET
I OSLO

Background

Ground-based optical measurements provides a unique way to monitor spatial and temporal variation of auroral activity at high resolution – up to 10 meters near optical zenith.

- All-sky camera
- Photometer



UNIVERSITETET
I OSLO

Colours in the aurora

630.0 nm – red upper boundary
Atomic Oxygen: 1D - 1S transition

557.7 nm – green
Atomic Oxygen : 1D - 3P transition

427.8 nm – magenta lower boundary
 N_2^+ - First negative band

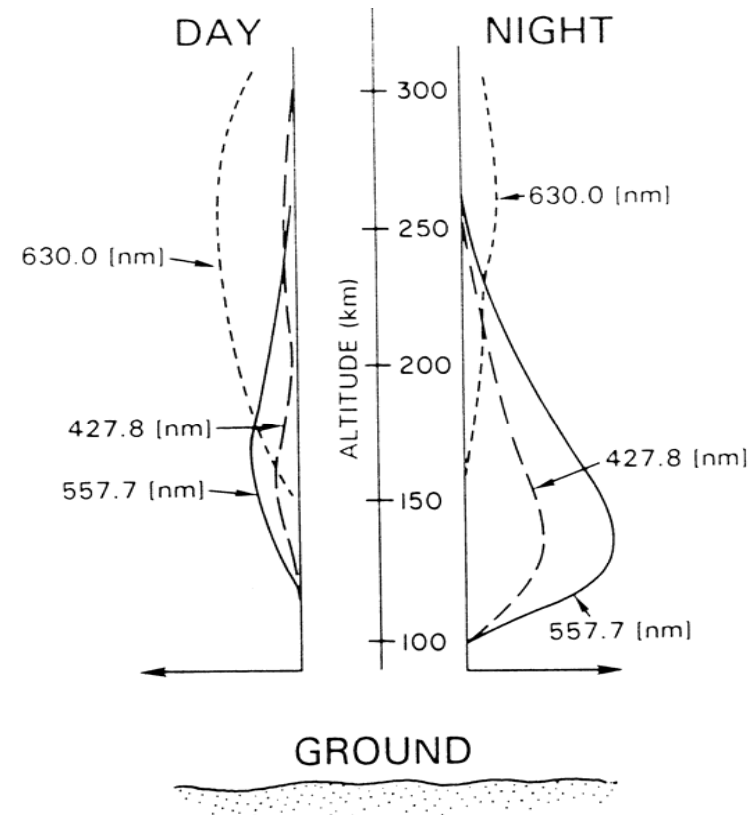



Optics and filters

- The optical part can be a lense or a lense system, used to focus the light on the detector(s).
- Two common type of filters:

Interference filter

Absorbtion filter

- The bandwidth of an absorption filter is much larger than for an interference filter.



UNIVERSITETET
I OSLO

Monochromatic filtering/ Narrow band interference filter

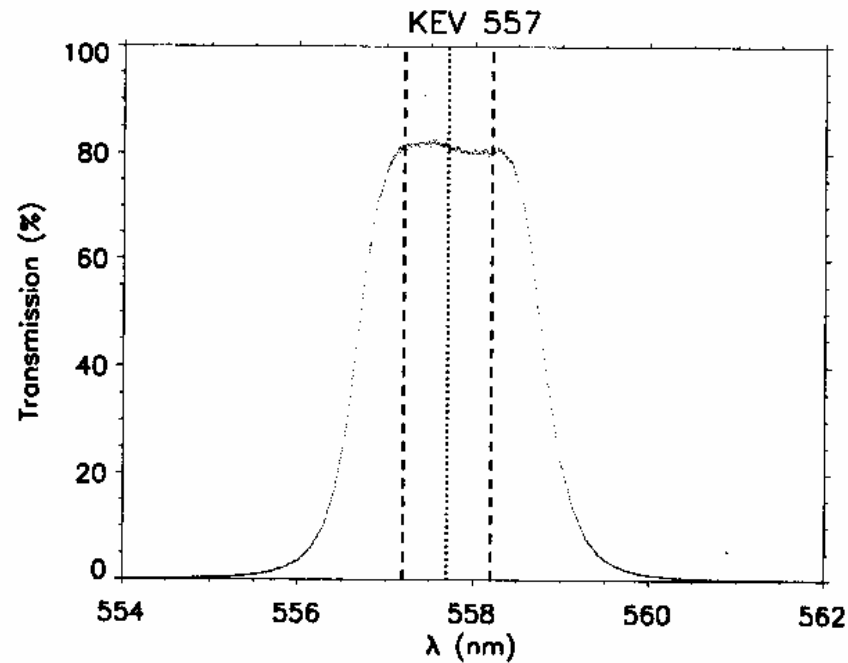

- CW 557.7
- FWHM is about 2-3 nm
- Transmission ~70-90 %
- Cavity 5



Interference filters

- Also called thin film or dichroic filter
 - Layers of optical coatings are build upon a glass substrate, reinforcing som wavelengths and interfering with others
 - Pass light of a small range of colors while reflecting others
 - Can also be used as mirrors/reflectors – chararterized by the wavelength they reflect (not pass)
 - Available as highpass, lowpass or bandpass/bandstop filters



Interference filters

- Coating for interference filters, usually metals

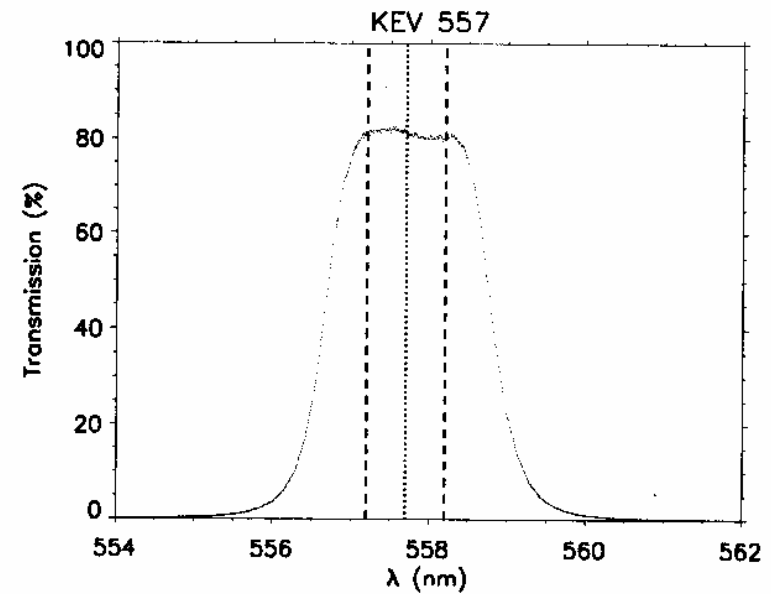
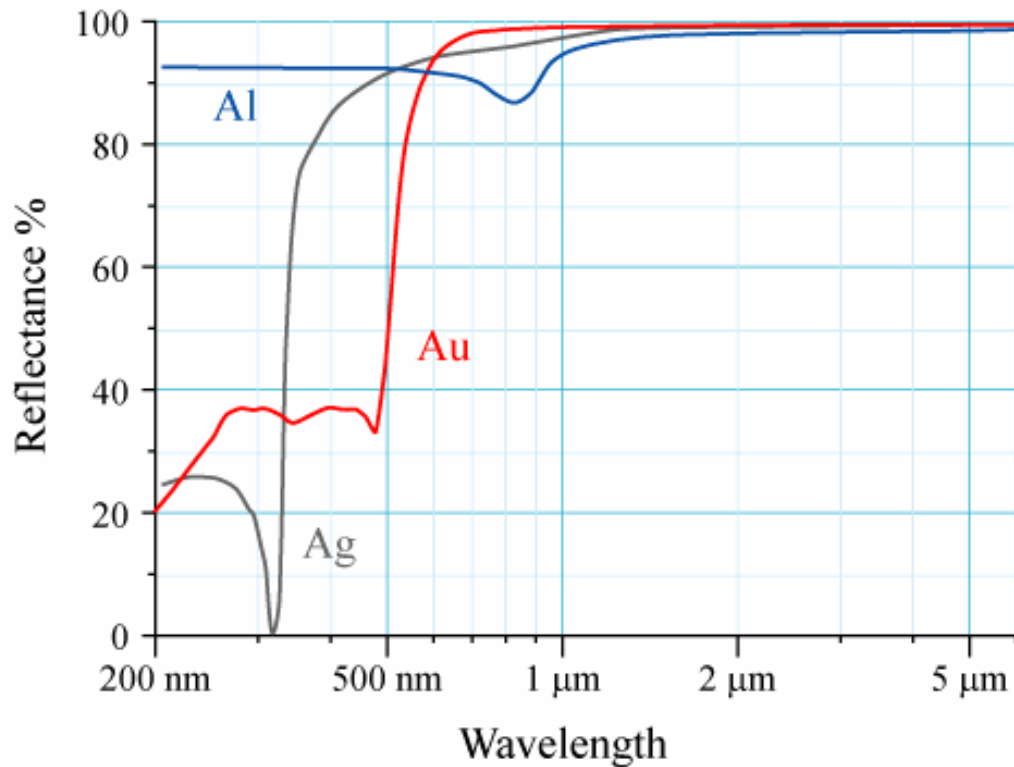



UNIVERSITETET
I OSLO

PHOTOMETERS

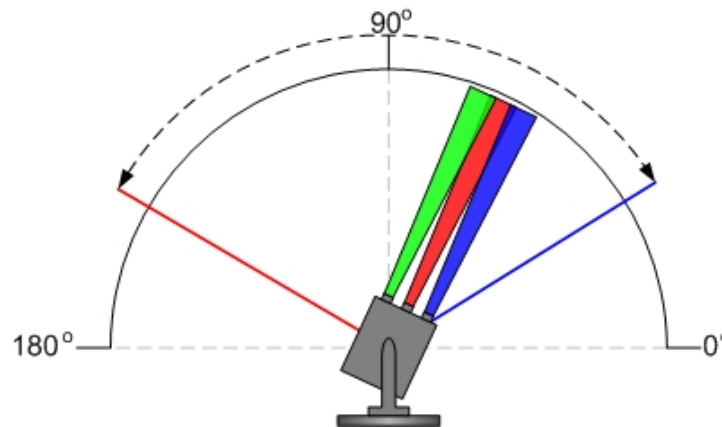



UNIVERSITETET
I OSLO

Photometer

- **Measures the light intensity (for a given wavelength).**
- Very sensitive.
- Good spatial resolution and time resolution.
- Same sensitivity in all directions.
- A photometer cannot image the auroral morphology, so it is used as a supplement to all-sky cameras.



UNIVERSITETET
I OSLO

Photometers – Operational mode

- It can be pointed at a fixed point (a given elevation). But this doesn't give any scientifically interesting data, since aurora typically has an extension of 100 – 1000 km.
- Therefore it is used in a scanning mode, where the instrument sweeps out a larger area. There are two possible modes:

Meridian scanning

Azimuth scanning

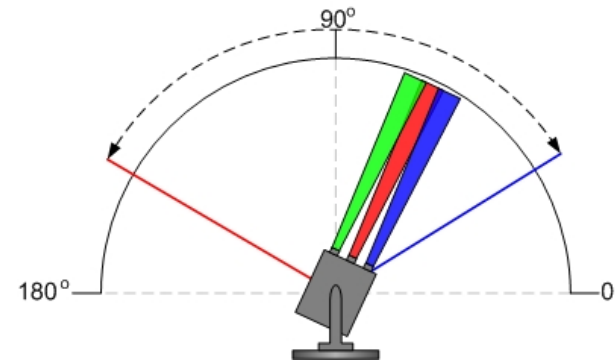

Meridian scan

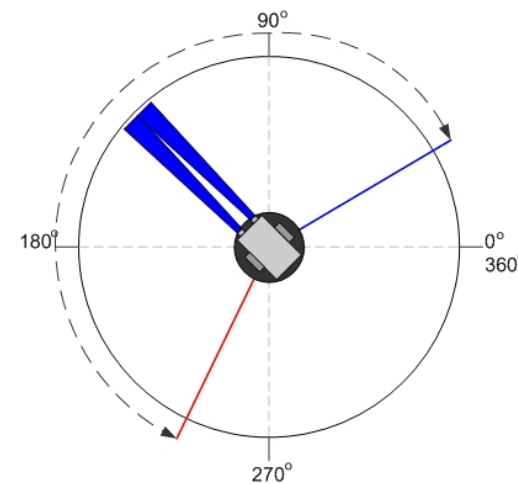

Azimuth scan



UNIVERSITETET
I OSLO

Photometers

- A photometer (with mobility around horizontal and vertical axes) can be programmed to follow a rocket trajectory, to compare the measurements of the particle precipitation and the aurora.



UNIVERSITETET
I OSLO

Photometer

- Optics
- Light detector
- Electronics/signal processing

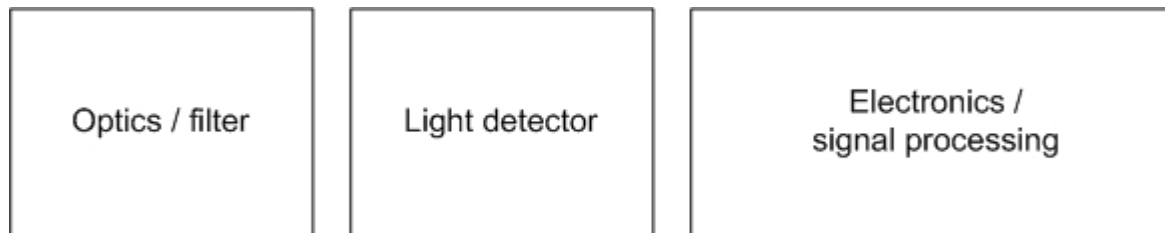



Optics – angular field of view

- The angular field of view decide how much of the sky the detector sees, and with that the photometers spatial resolution.
- We want as large resolution as possible (small angular field of view), but at the same time as much light as possible into the detector. This is incompatible.
- A common compromise is to have an angular field of view of $\sim 2^\circ$ (the angular field of view of the moon seen from the earth is $\sim 0.5^\circ$)

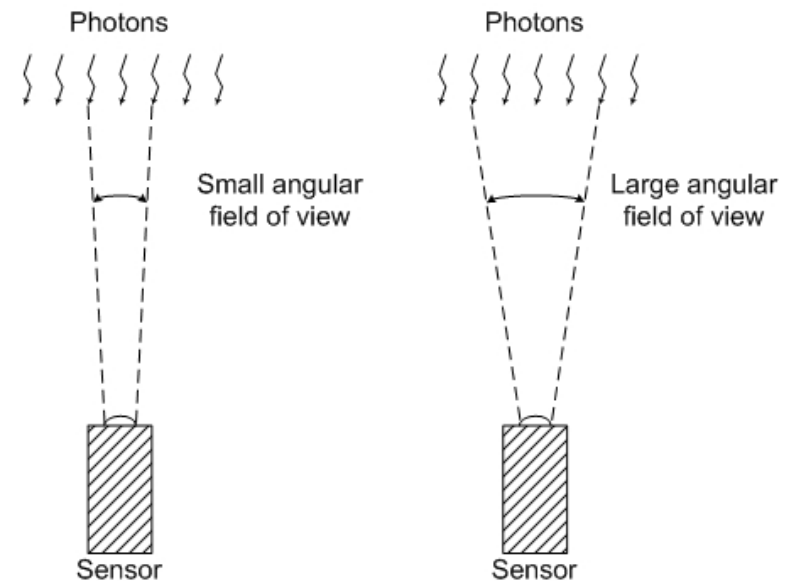



UNIVERSITETET
I OSLO

Optics – angular field of view

- A lense system can be used to define the angular field of view.
- A single lense and an aperture opening in front can be used to define the angular field of view.



UNIVERSITETET
I OSLO

Photon Detector

- The detector is usually a photomultiplier
- A Charge-Coupled Device (CCD) can also be used, and CCD based photometers are used in many satellites.
- In satellites and rockets the photomultiplier tubes and the high voltage source are usually sealed in a silicone die, to prevent corona discharge and to attenuate (damp down) the vibrations.



UNIVERSITETET
I OSLO

PhotoMultiplier Tube(PMT)

- When a photon of sufficient energy hit the photocatode, a single electron may be ejected (referred as a photoelectron).
- **The probability that a single photon produce a photoelectron that is detected in the phototube is called the quantum efficiency (QE).**

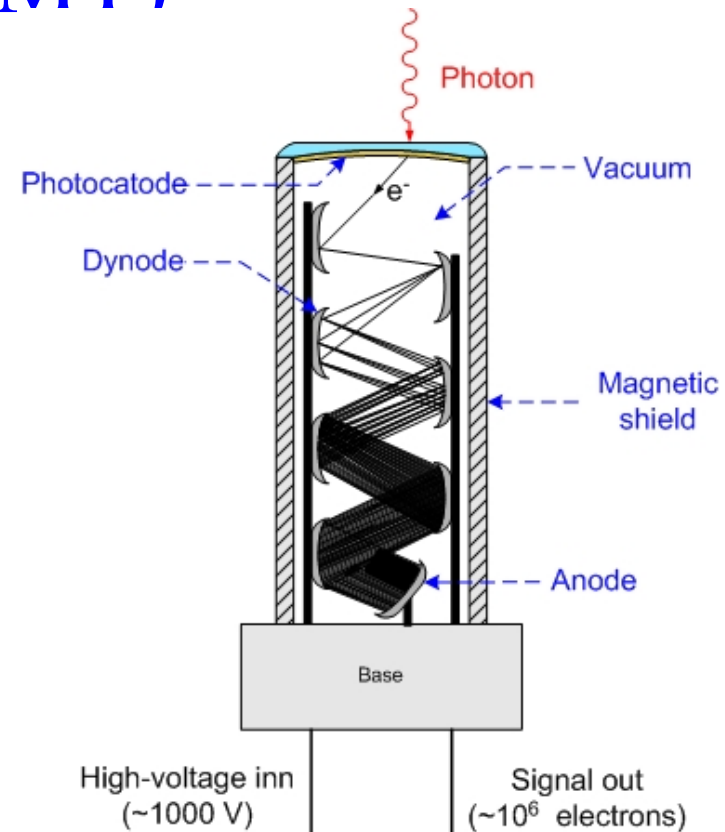



UNIVERSITETET
I OSLO

Photomultiplier

- QE is a function of the wavelength of the incident photon.
- A typical value for quantum efficiency in a phototube is 20 - 30% (at wavelength of 400 nm).



UNIVERSITETET
I OSLO

PMT Response curves

response curves

fig 1

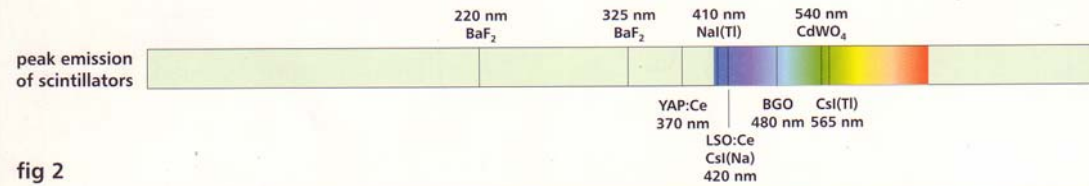
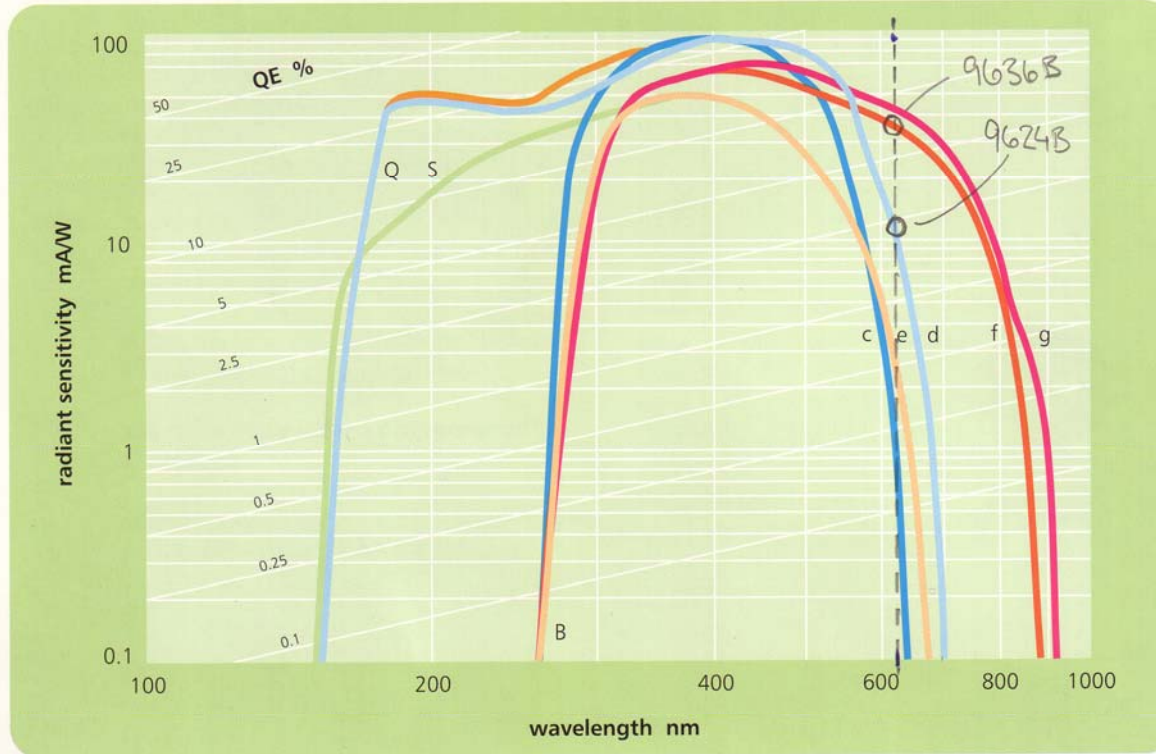

fig 2



UNIVERSITETET
I OSLO

Photomultiplier

- The photoelectron is accelerated through a potential difference, and hits a secondary electrode called a **dynode**.
- At the this first dynode the photoelectron frees other electrons, and this secondary electrons are accelerated and focused on a second dynode and so on.

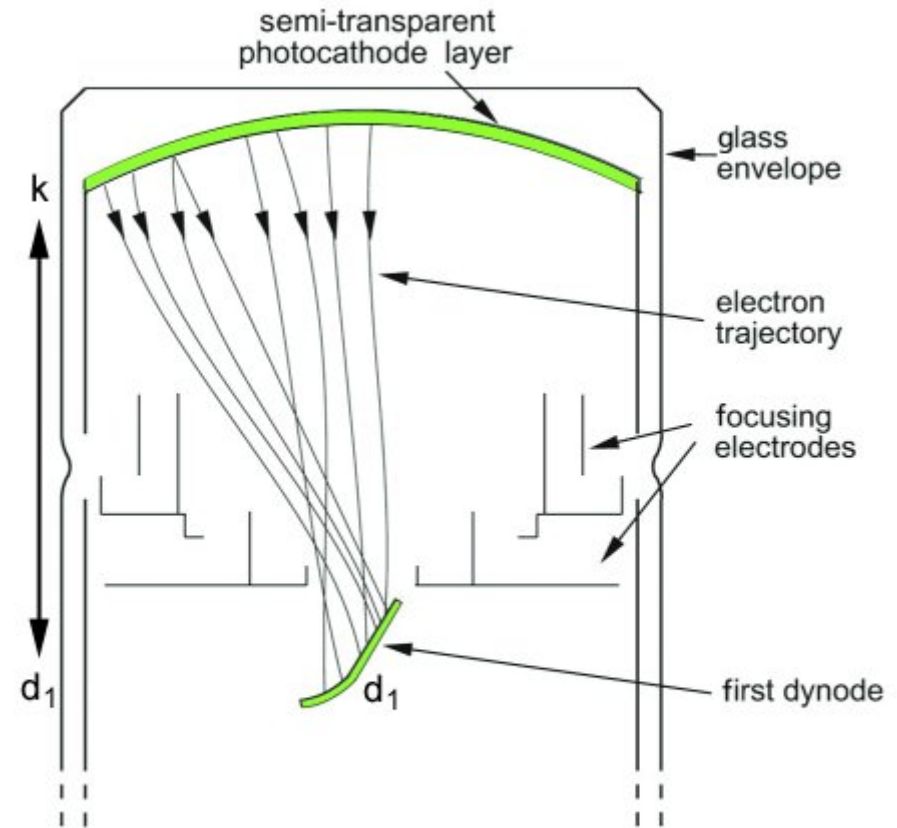

Photoelectron trajectories between photocathode and first dynode.



Photomultiplier

- The multiplication effect takes place at the dynodes, and the process results in an increasing number of available electrons (avalanche effect).
- The electrons are guided by the electrostatic field between the dynodes.
- An external magnetic field can distort the focusing, as the electrons travel from dynode to dynode. Therefore the photomultiplier tubes are shielded.



Photomultiplier

- A photomultiplier typically have 10 – 12 stages (dynodes) and a multiplication of $\sim 10^6$
→ This signal is easily detected in an external circuit.

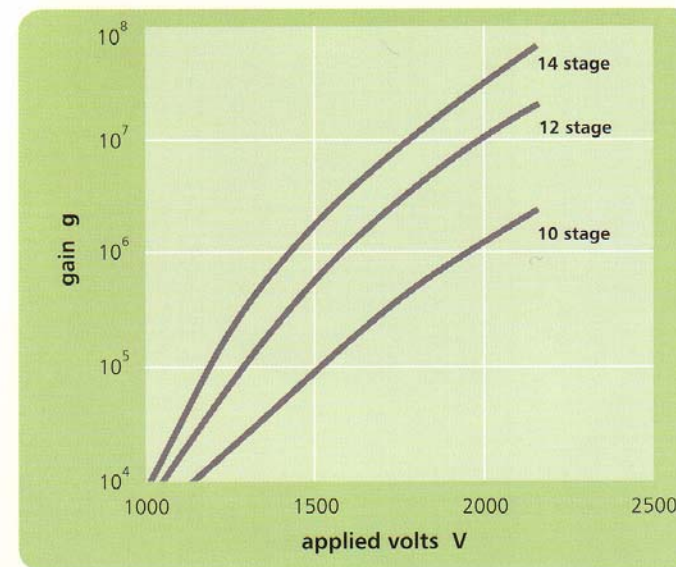
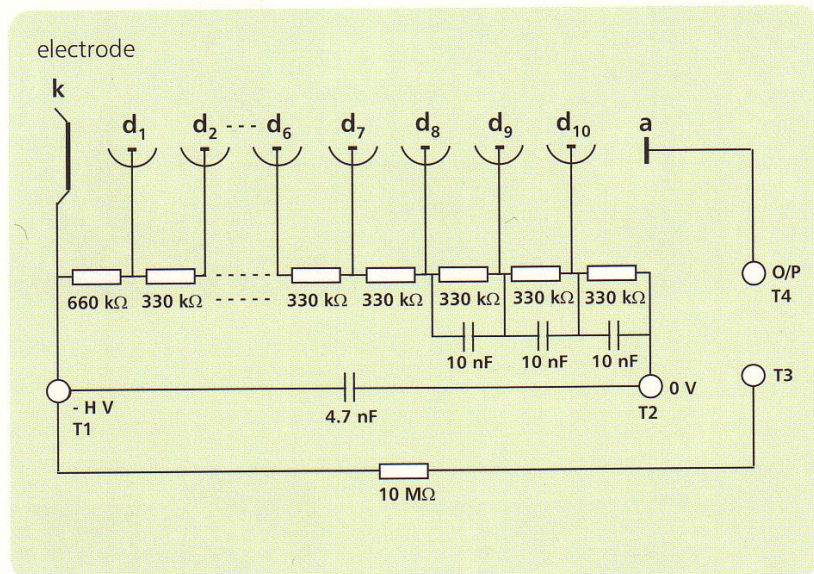

figure 6
Variation of pmt gain, g , with applied voltage for the family of fast, BeCu, 52 mm pmts, illustrating the effect of increasing the number of dynodes



UNIVERSITETET
I OSLO

Photomultiplier

- The total voltage (the potential difference between the photocathode and the anode) is typically 1000 – 2000 volt.
- Can be used in current or photon counting mode
- Photomultipliers are sensitive detectors of single photons, and as such are designed to operate in the dark.



UNIVERSITETET
I OSLO

Electronics /signal processing

- The output signal from the photomultiplier is current pulses, where each pulse correspond to a detected photon.
- This current pulses are converted to voltage pulses by a current to voltage converter.
- Some of the voltage pulses generated are caused by noise, and thereby not desired. To eliminate them, a **voltage discriminator** is inserted. The discriminator is adjusted to remove all pulses with an amplitude smaller than a predefined limit.



Noise

- There are several noise sources, but the dominating noise source for the photomultiplier tube is thermal electron emission from the photocathode (can be reduced by cooling).
- This noise results in what is known as dark current or dark counts; dark counts is the number of counts made by the photomultiplier when it is in complete darkness.
- The dark current must be as low as possible, since it sets the lower limit on how low intensity the instrument can detect.



UNIVERSITETET
I OSLO

Meridian Scanning Photometer data from Longyearbyen

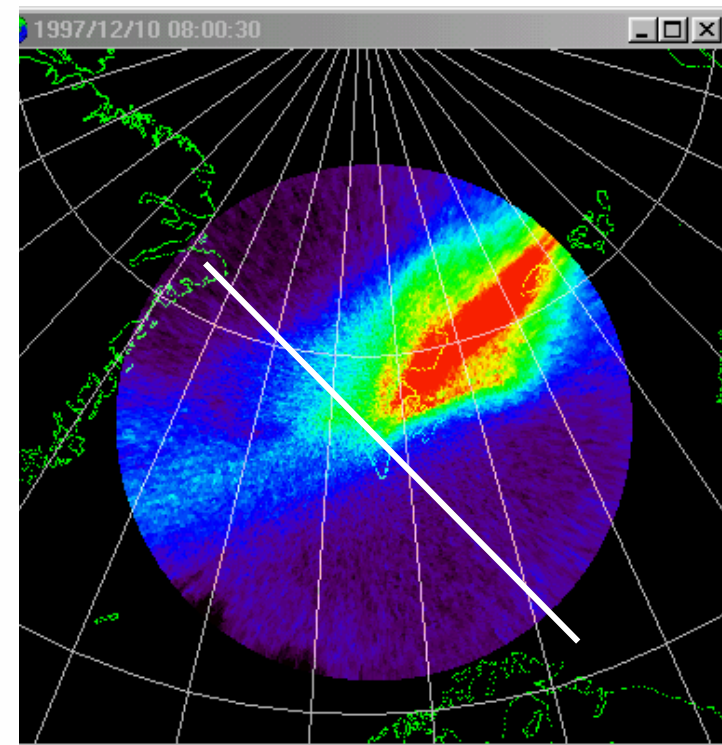
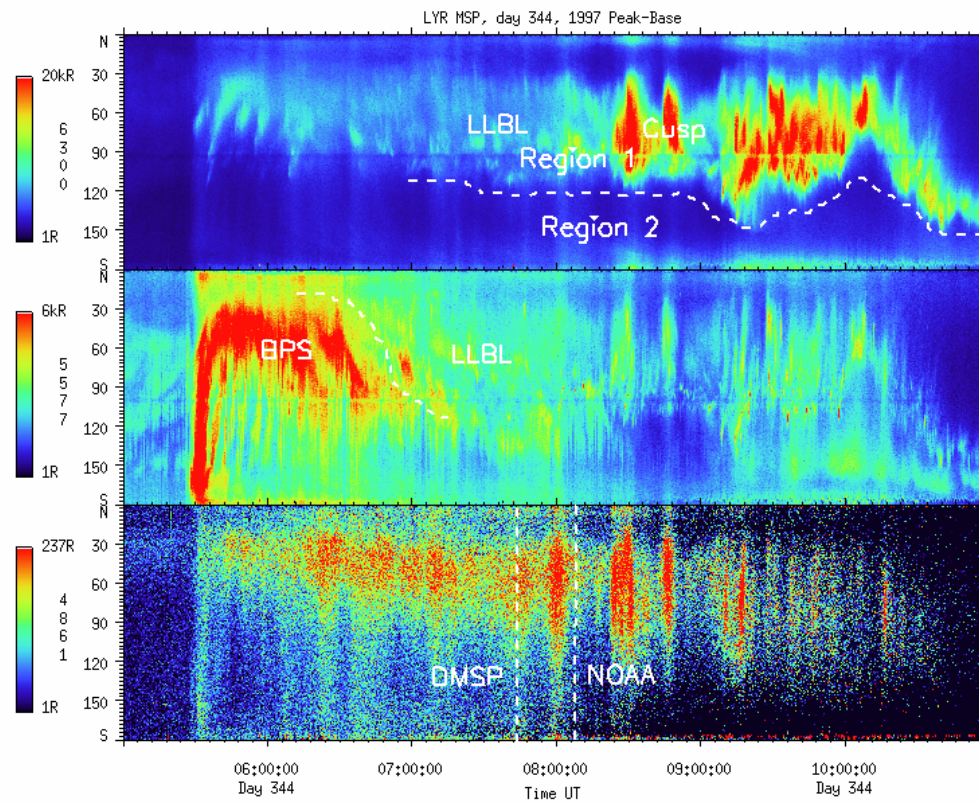



UNIVERSITETET
I OSLO

CCD All-sky Camera with filterwheel

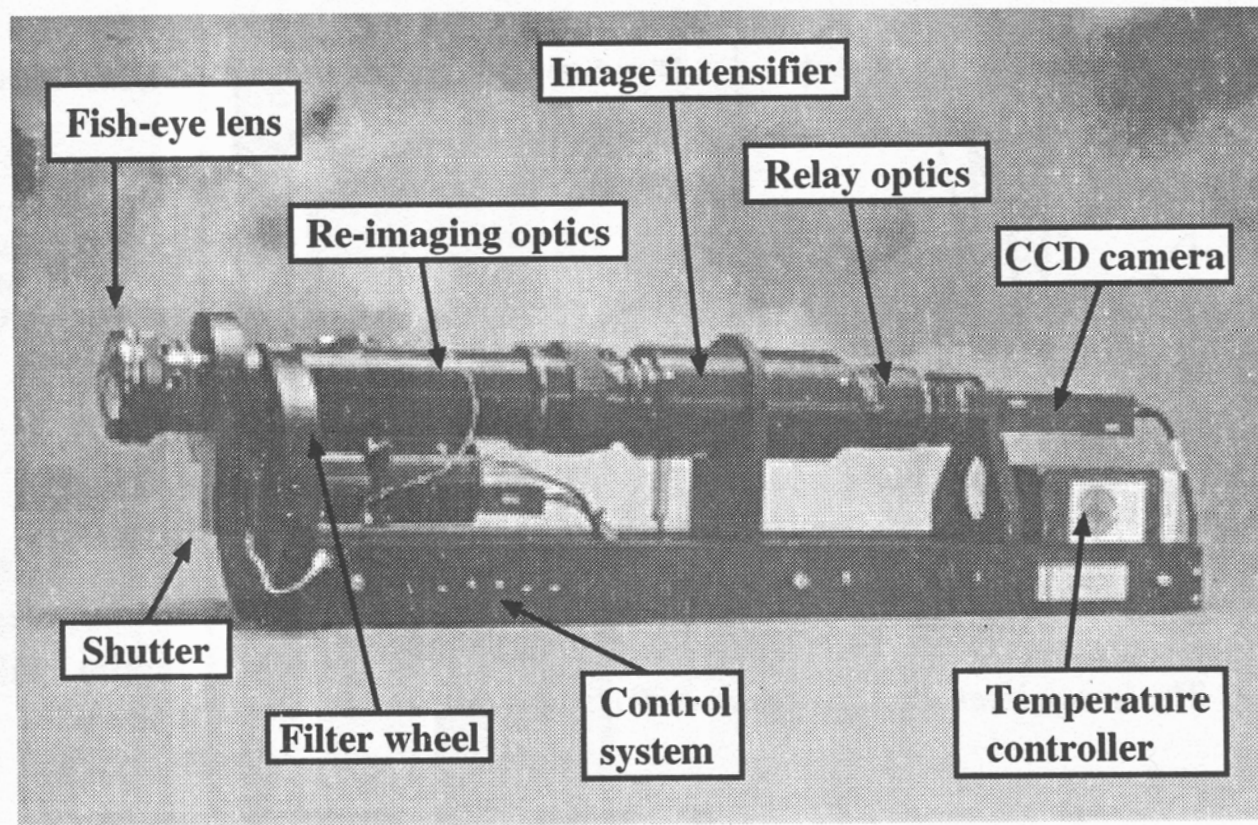



UNIVERSITETET
I OSLO

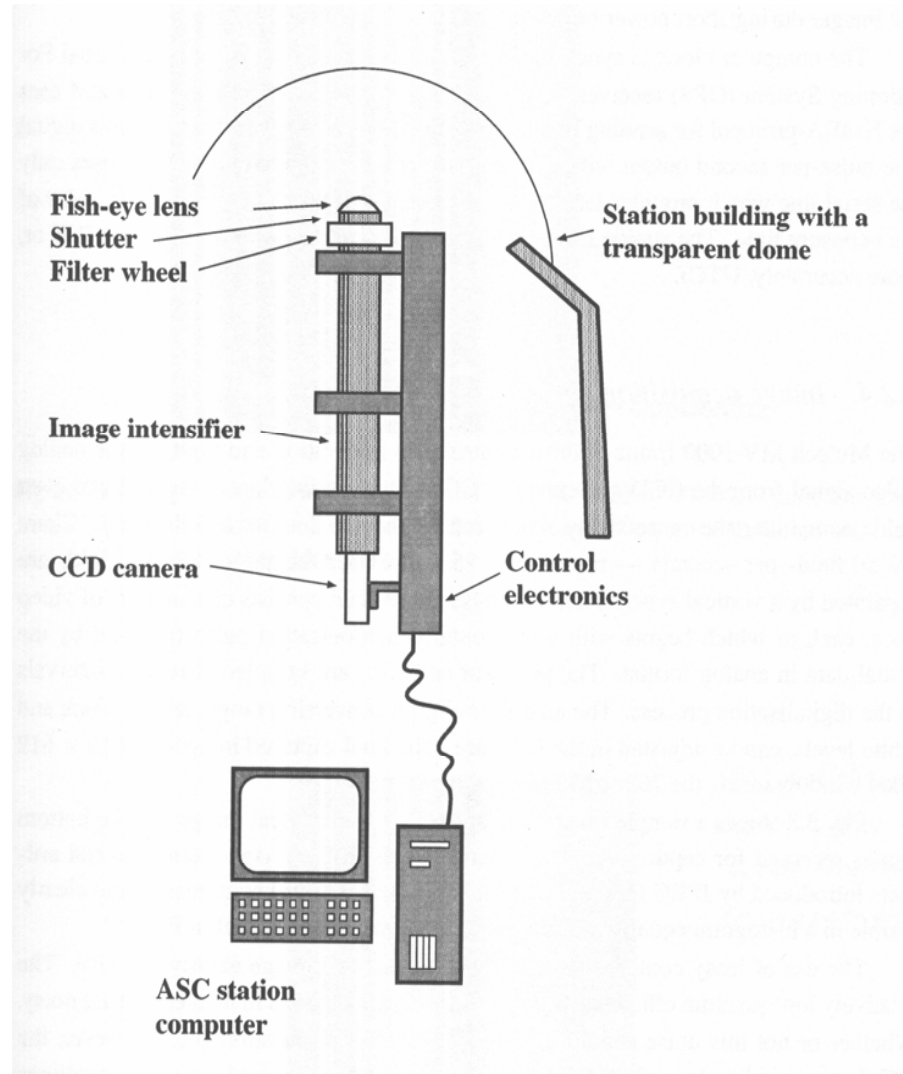



UNIVERSITETET
I OSLO

Image intensifier

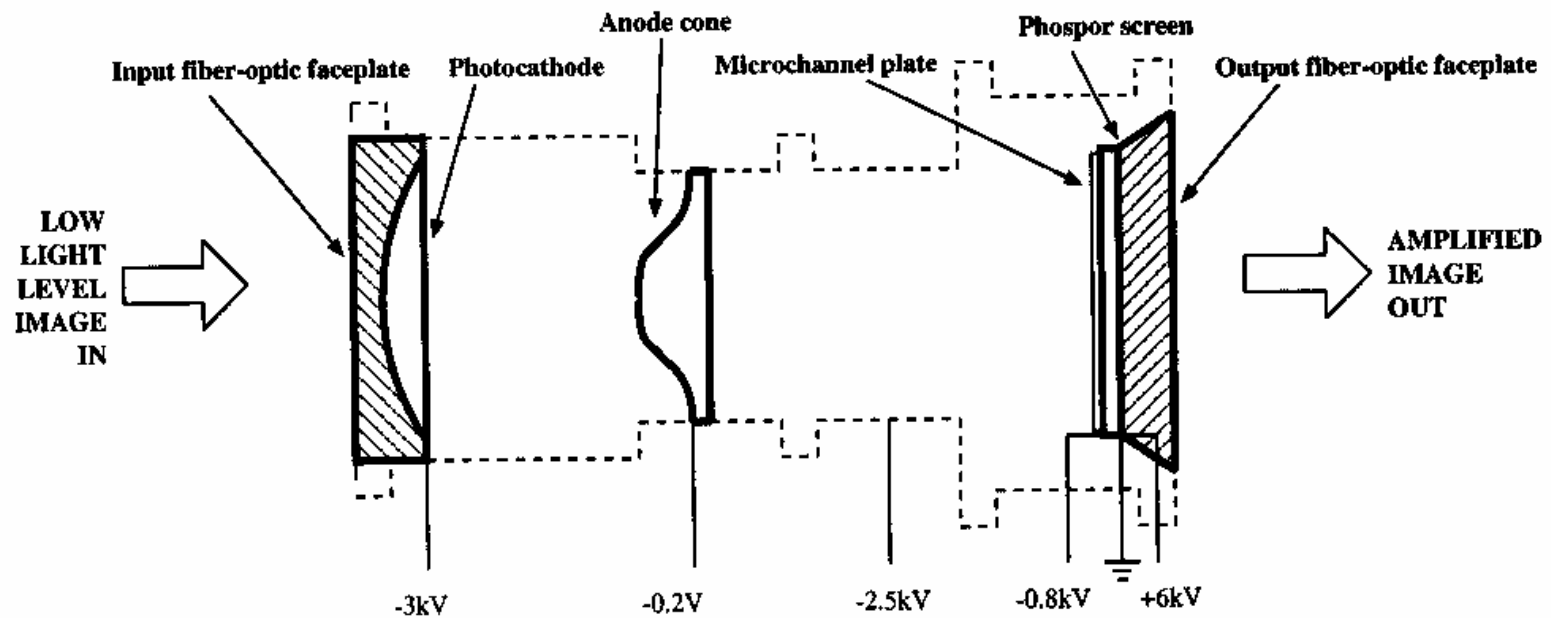



UNIVERSITETET
I OSLO

Image intensifier

■ Four generations of intensifiers

- 1: Still in use in security system. Cheap, blurry image, afterglow.
- 2: Introduces the micro-channel plate, better amplification, brighter and sharper images.





UNIVERSITETET
I OSLO

Image Intensifier

- 3: New, improved photocathode, sharper, longer lifetime
- 4: Better signal/noise ratio. Tripple resolution compared to third generation.





UNIVERSITETET
I OSLO

Image Intensifiers

- Comparing 3. and 4 generation:

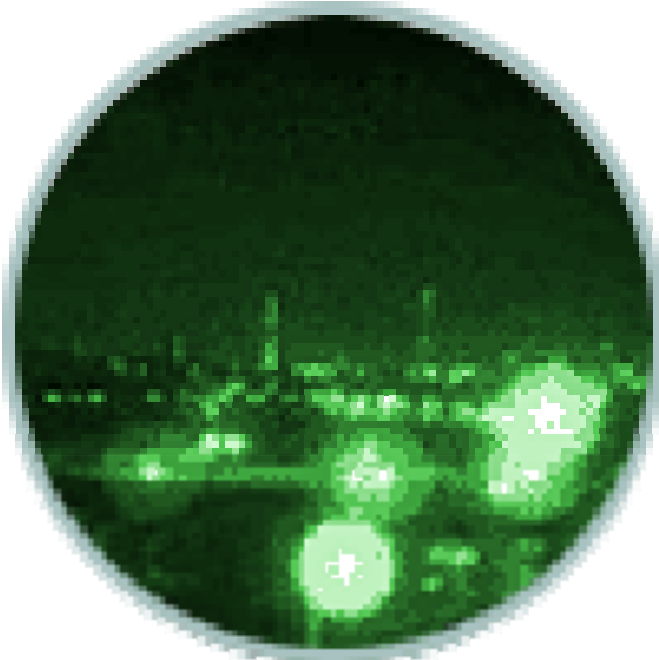



CCD light detector

- Each detector element (pixel) measures the intensity in incoming light, and sends out a signal which is proportional with the light intensity.
- The pixels are arranged in an array; typically 512 x 512 and up to 2000 x 2000 pixels.
- More pixels = higher resolution and more data
- Modern pixel sizes are between 4 and 10 μm in height and width

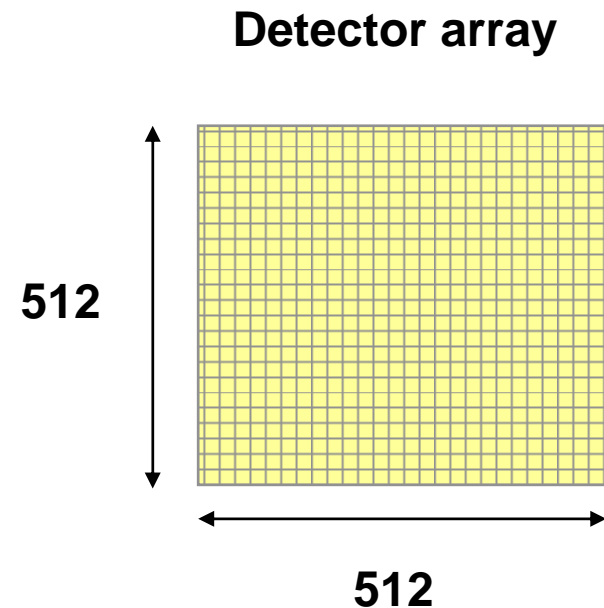



Charge-coupled device (CCD)

- Consist of thousands of light sensitive elements arranged in an array.
- **Each element is an** oxide semiconductor (MOS) **capacitor.**
- The photoelectric effect produce charges on this capacitors.

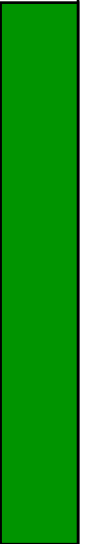
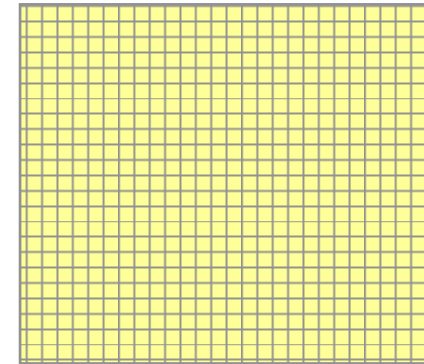



Charge-coupled device (CCD)

- The charges in each capacitor row is shifted to the output, and each charge is converted to a voltage.

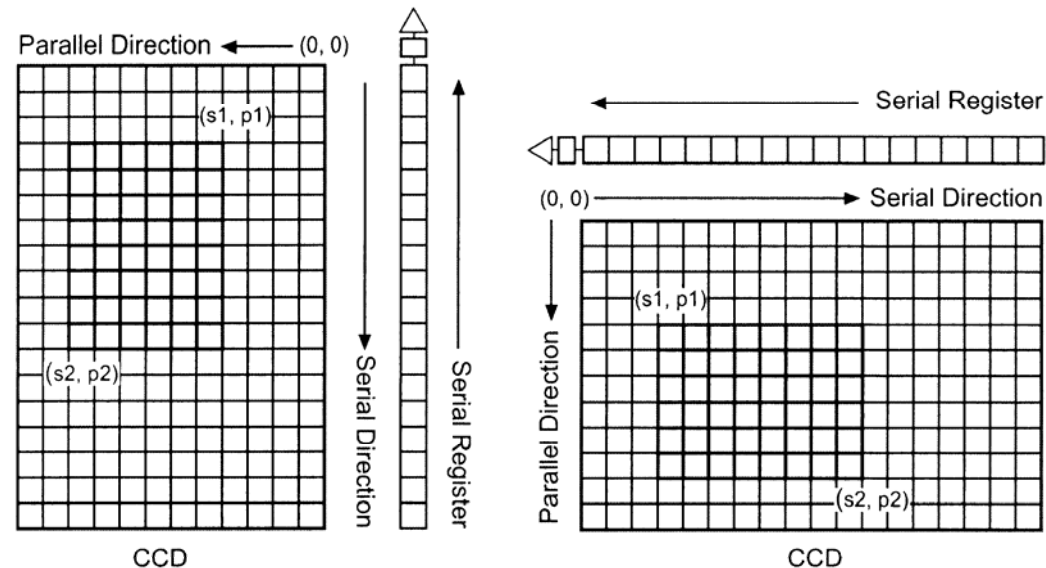

Regions and Images



UNIVERSITETET
I OSLO

Charge-coupled device (CCD)

- The advantage of the CCD is that no high voltage is required (compared to the photomultiplier).
- The disadvantage is low time resolution (because it is an integrating type of detector) and it is therefore not suitable to look at very weak photon sources (without use of a light amplifier)



Charge-coupled device (CCD)

- The quantum efficiency (QE) is typically 40 to 80 % for a CCD.
- As for a PMT, QE is dependent of wavelength
- **But**, even if a photon produce one electron in the detector, this electron is not necessary detected at the detector output. Because this photon can get lost during signal transportation or be burried in noise. So QE is not a good measure of how good the detector system is.



UNIVERSITETET
I OSLO

Geometry of auroral observations

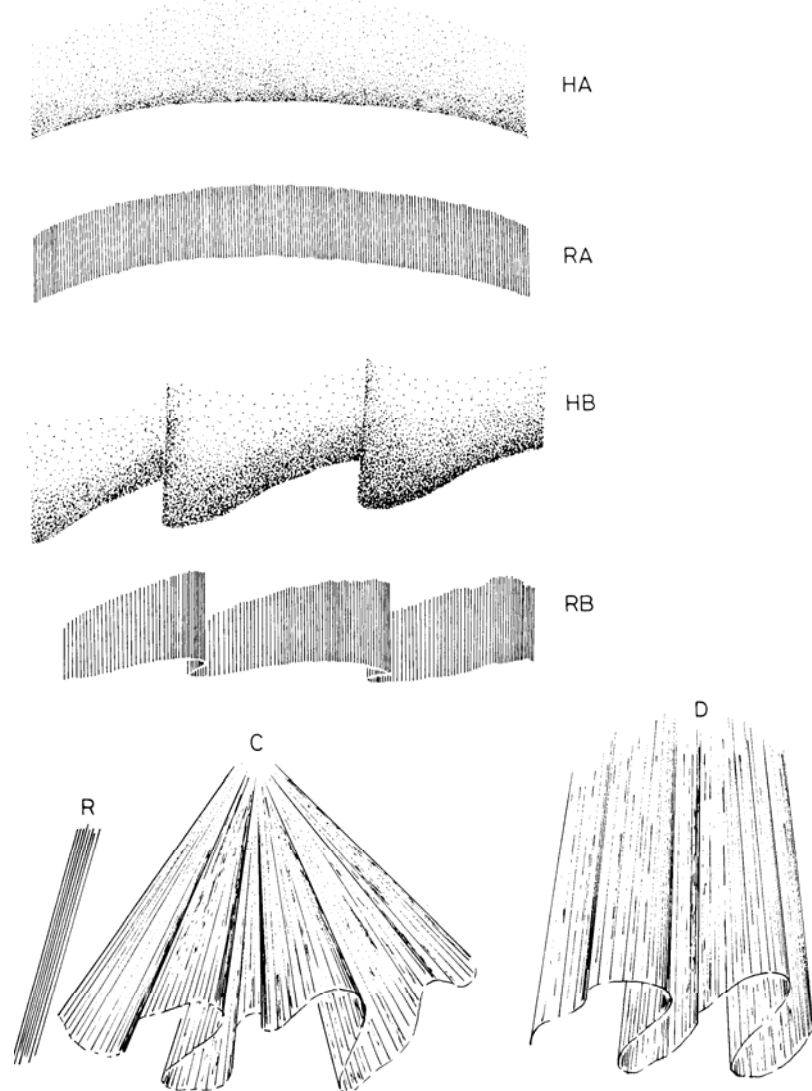
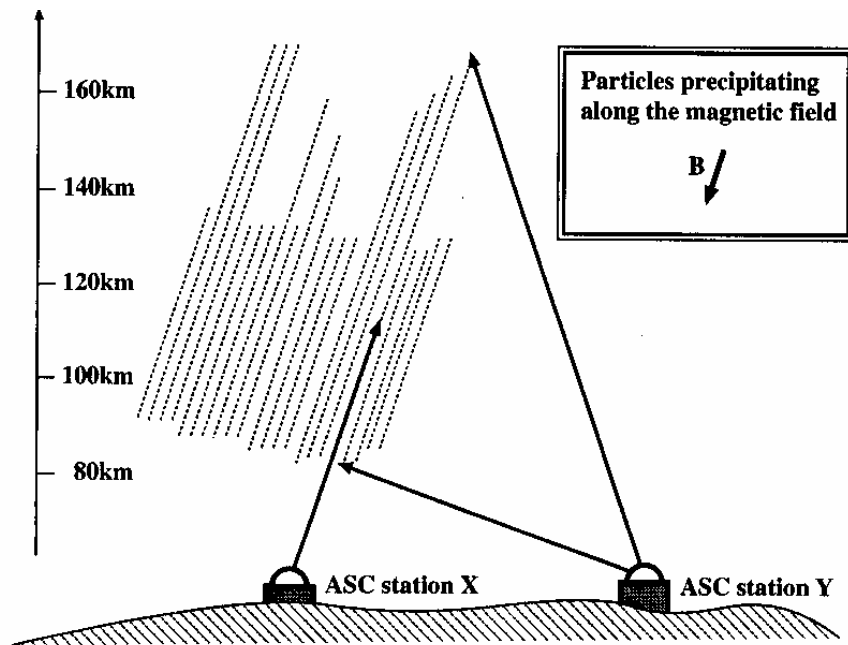



UNIVERSITETET
I OSLO

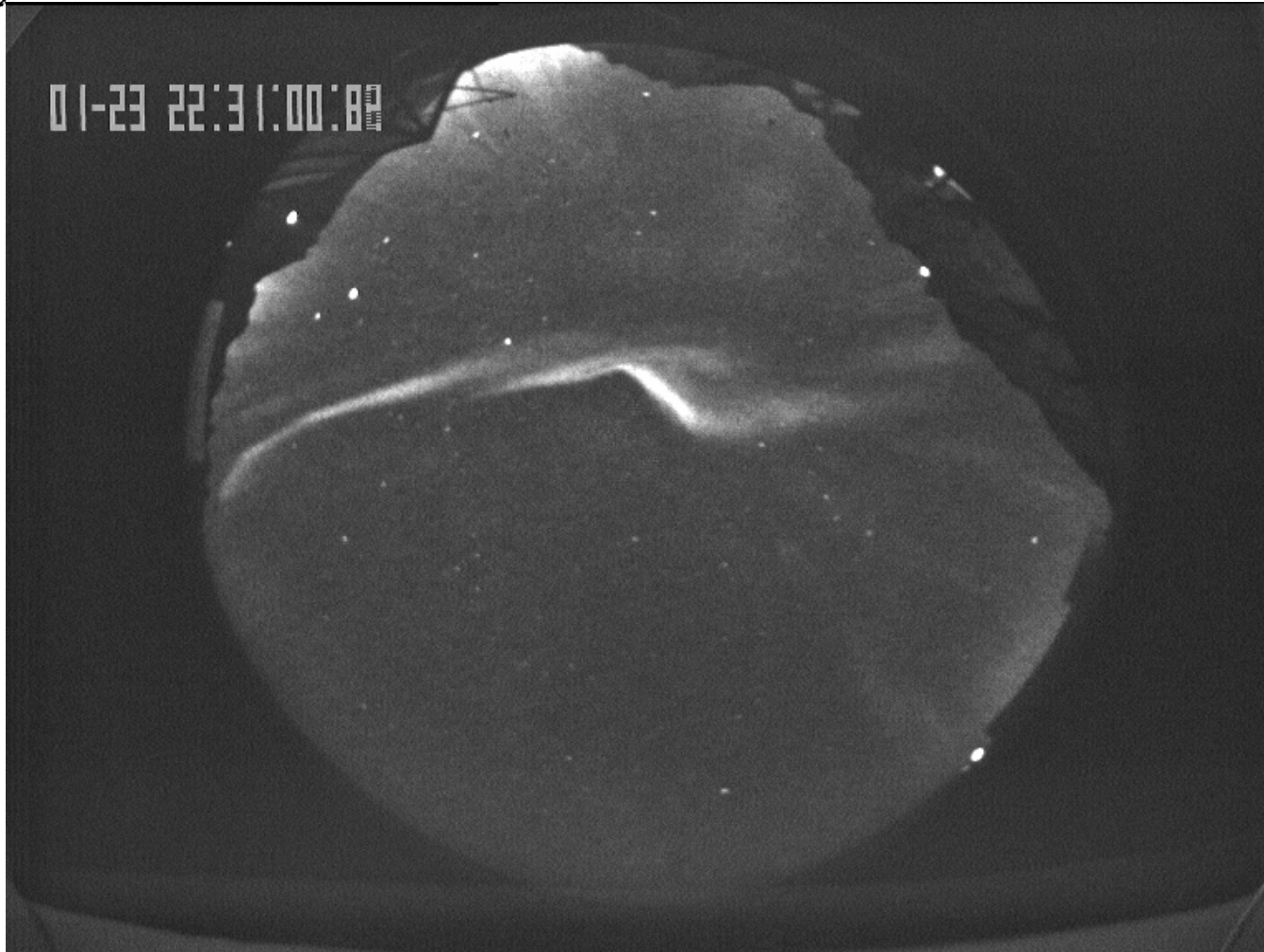

© Research Section for Plasma and Space Physics

**White light image from ARR
unmapped**



UNIVERSITETET
I OSLO

Be also aware of flipping!!

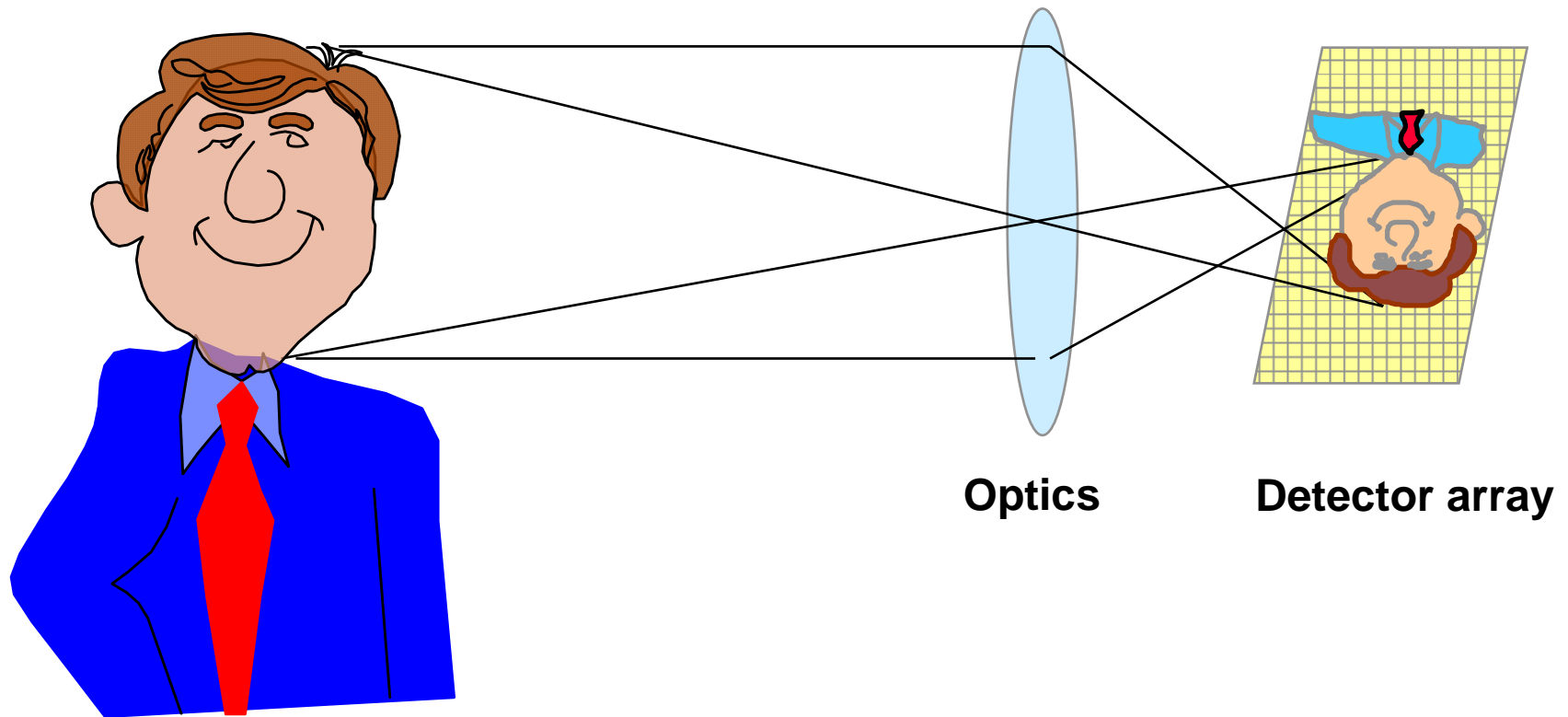



UNIVERSITETET
I OSLO

Gegraphical coverage depends on emission altitude

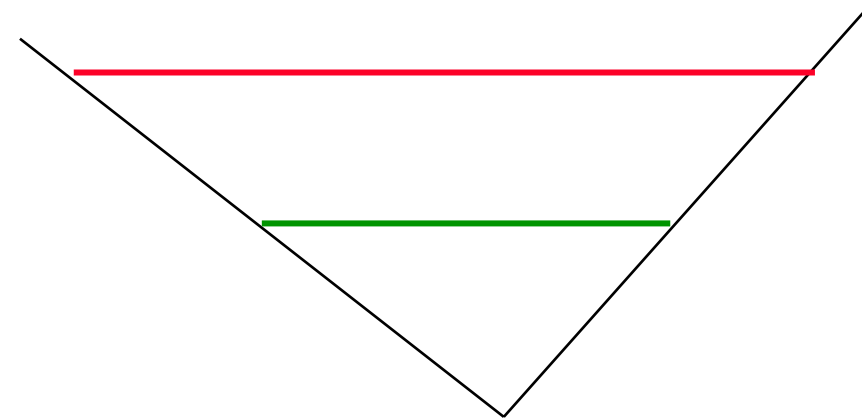
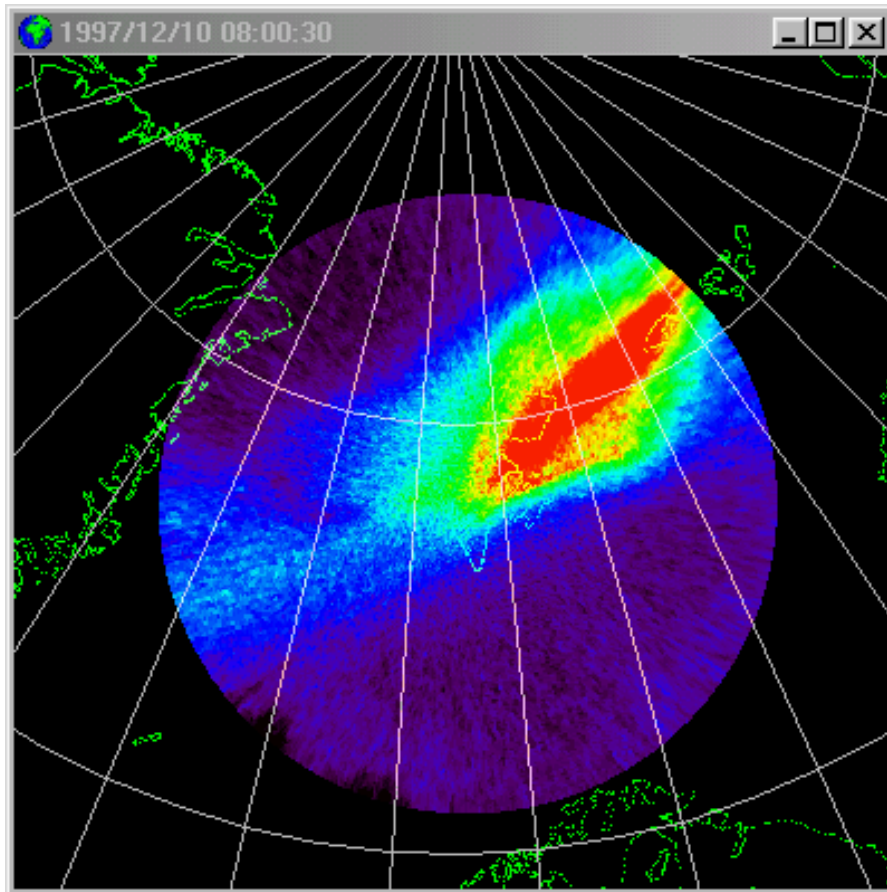

**630.0 nm image mapped
to 250 km altitude**



UNIVERSITETET
I OSLO

20 Oct 2006 03:41:31 GMT

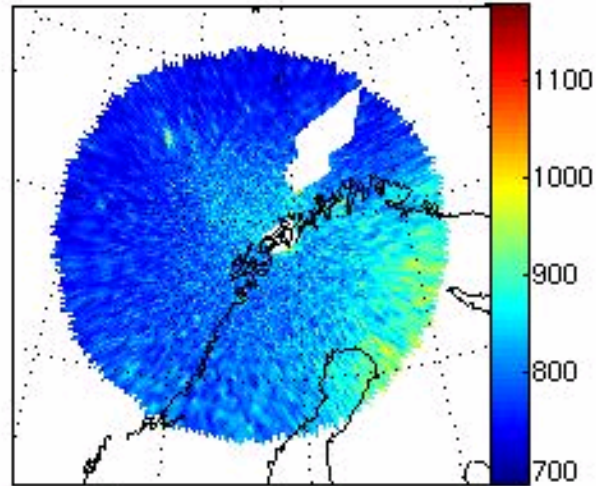

20 Oct 2006 03:41:20 GMT

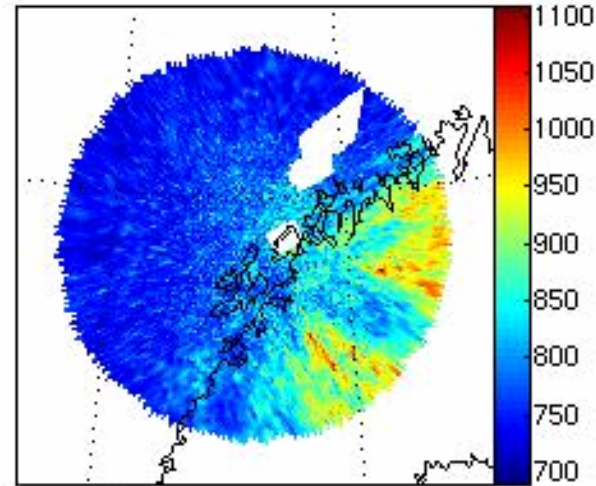

6300 Å. Exp. 1800 ms. @250 km.

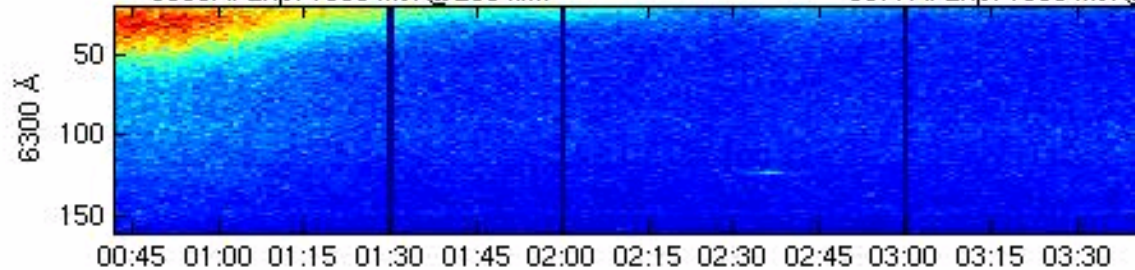

5577 Å. Exp. 1000 ms. @120 km.

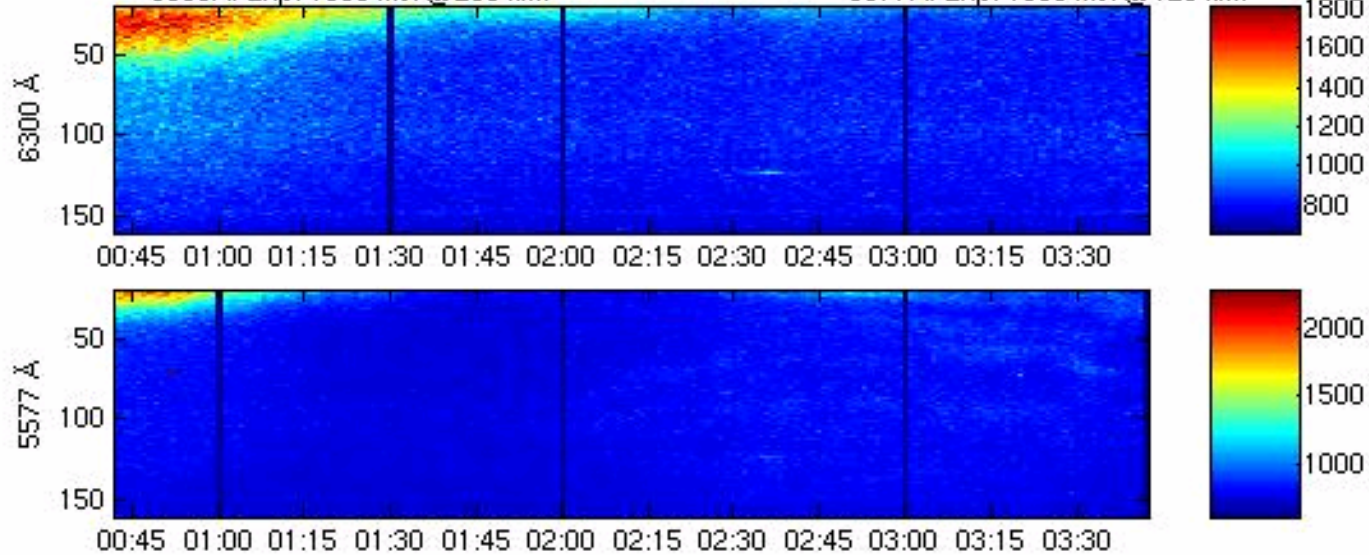



UNIVERSITETET
I OSLO

FoV of ground based instruments

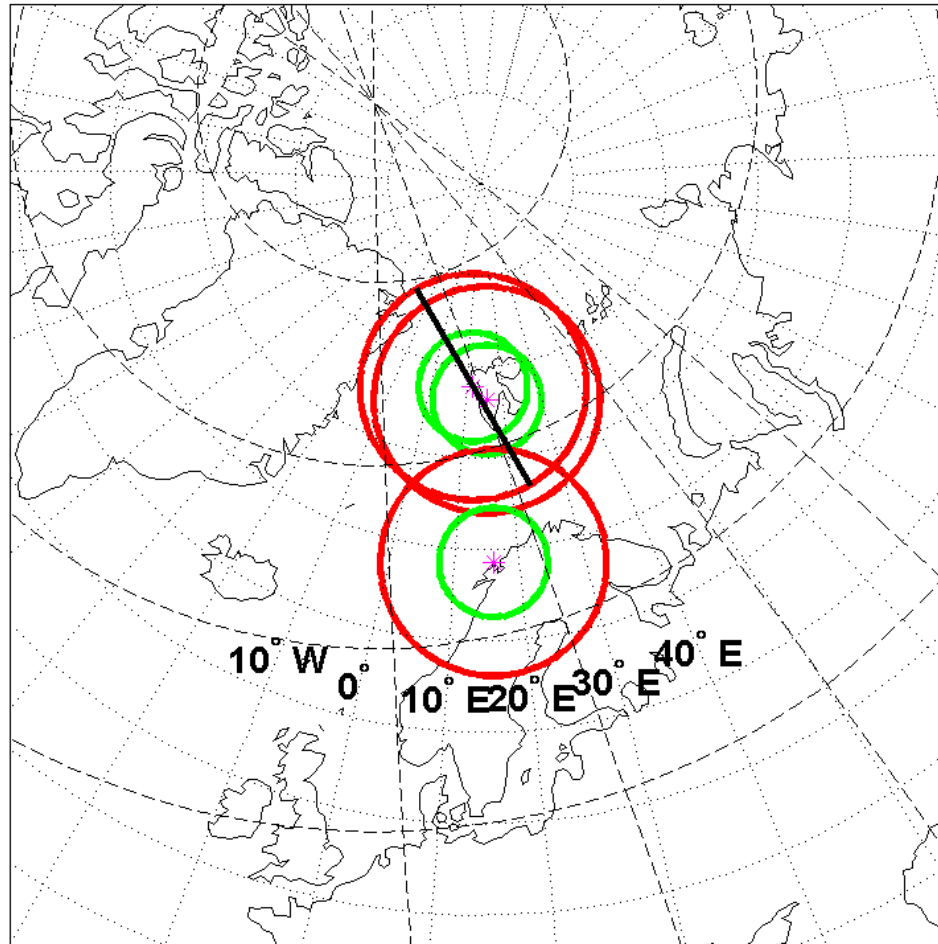

FoV: 70 deg, 630.0 nm @ 250 km, 557.7 nm @ 120 km.



UNIVERSITETET
I OSLO

