

# Elasticity and Structures

- Elasticity:
  - Stress (Mekanisk spenning)
  - Strain (Tøyning)
  - Elastic constants
  - Anisotropic materials
  - Fracture (brudd)
  - Thin film stress
- Structures:
  - Beams
    - Beam equation
    - Solutions for different loads
  - Plates (later, in connection with piezoresistors)
    - Plate equation
    - Solutions

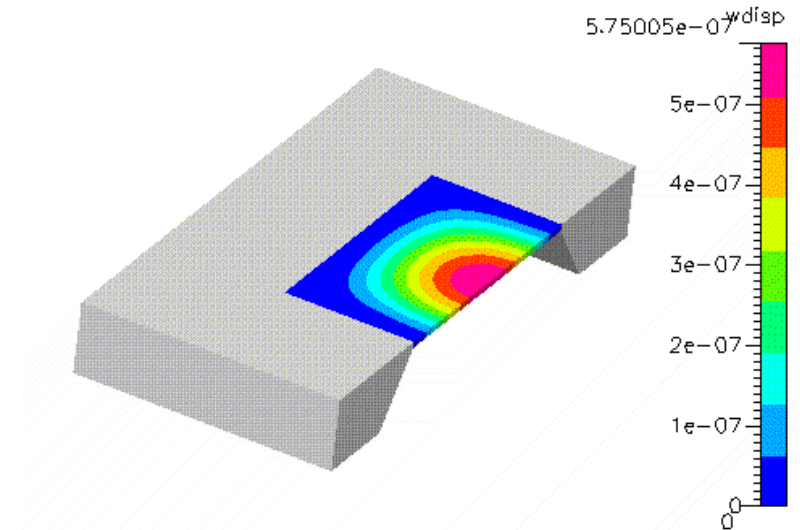

# Translating biomolecular recognition into nanomechanics

Science 288, 2000

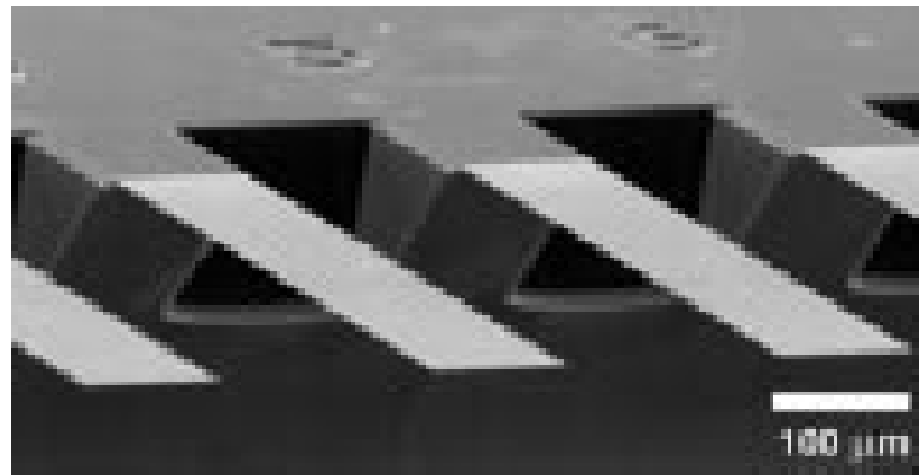

Fig. 1. Scanning electron micrograph of a section of a microfabricated silicon cantilever array (eight cantilevers, each 1  $\mu\text{m}$  thick, 500  $\mu\text{m}$  long, and 100  $\mu\text{m}$  wide, with a pitch of 250  $\mu\text{m}$ , spring constant 0.02  $\text{N m}^{-1}$ ; Micro- and Nanomechanics Group, IBM Zurich Research Laboratory, Switzerland).

## Bulk silicon micromachining

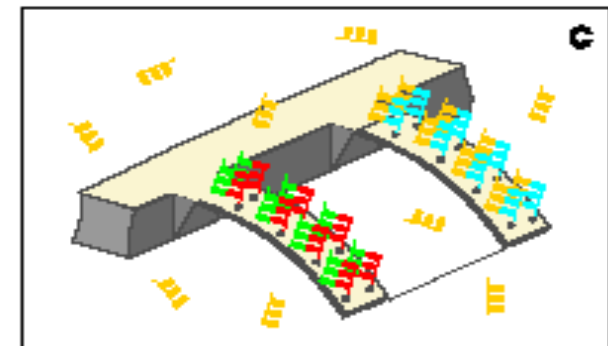
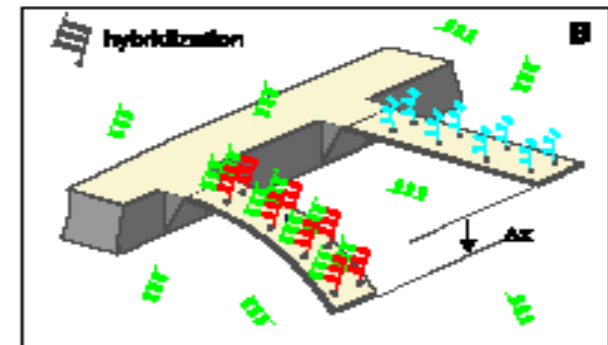
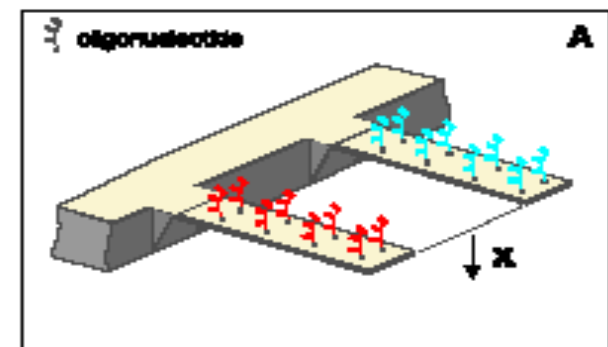

Fig. 2. Scheme illustrating the hybridization experiment. Each cantilever is functionalized on one side with a different oligonucleotide base sequence (red or blue). (A) The differential signal is set to zero. (B) After injection of the first complementary oligonucleotide (green), hybridization occurs on the cantilever that provides the matching sequence (red), increasing the differential signal  $\Delta x$ . (C) Injection of the second complementary oligonucleotide (yellow) causes the cantilever functionalized with the second oligonucleotide (blue) to bend.

## A chemical sensor based on a microfabricated cantilever array with simultaneous resonance-frequency and bending readout

F.M. Battiston<sup>a,\*</sup>, J.-P. Ramseyer<sup>a</sup>, H.P. Lang<sup>a,b</sup>, M.K. Baller<sup>a,b</sup>, Ch. Gerber<sup>b</sup>,  
J.K. Gimzewski<sup>b</sup>, E. Meyer<sup>a</sup>, H.-J. Güntherodt<sup>a</sup>

<sup>a</sup>*Institute of Physics, University of Basel, Klingelbergstrasse 82, CH-4056 Basel, Switzerland*

<sup>b</sup>*IBM Research Zurich Research Laboratory, Säumerstrasse 4, CH-8803 Rüschlikon, Switzerland*

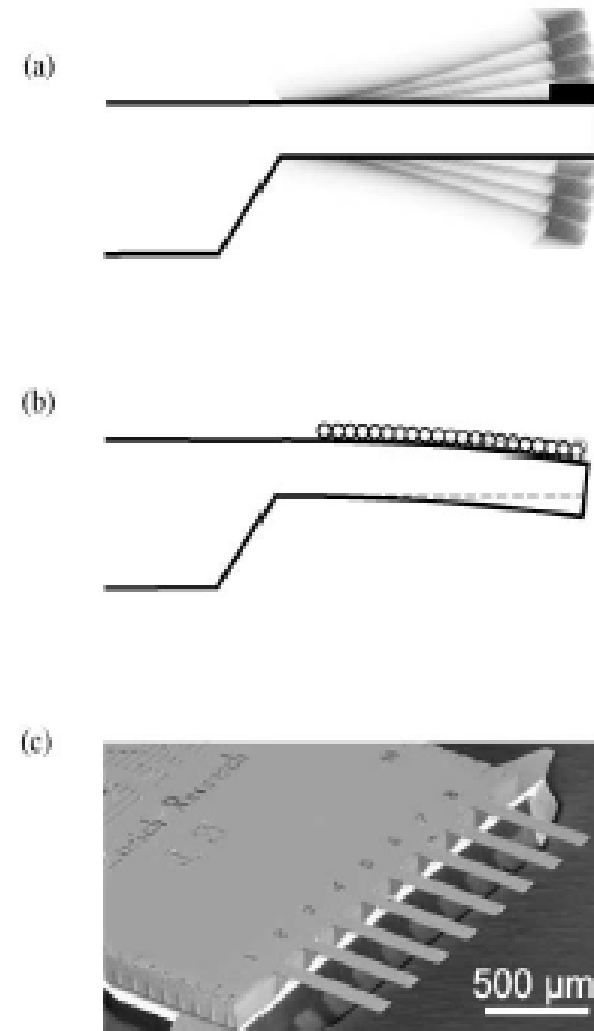
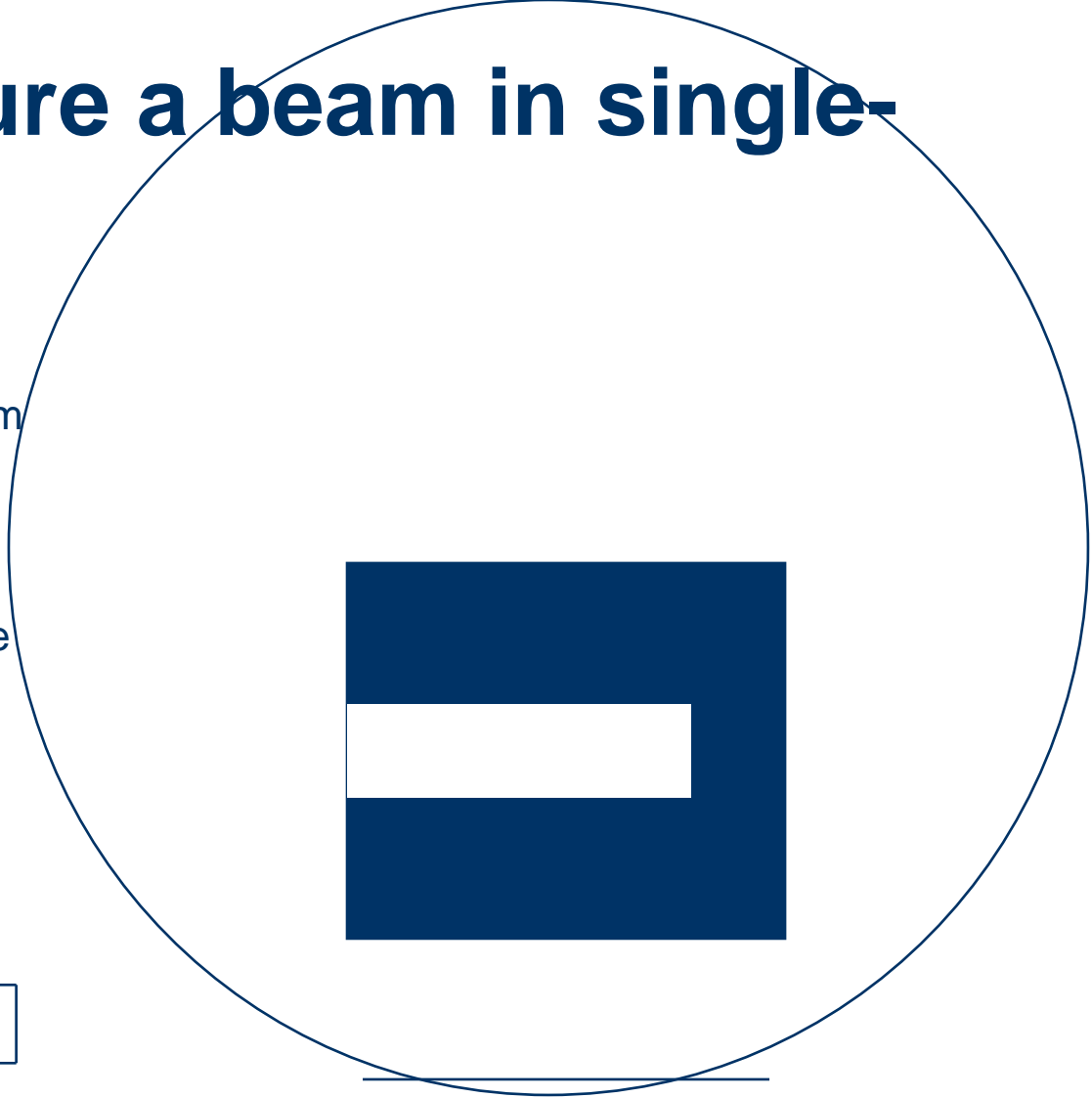
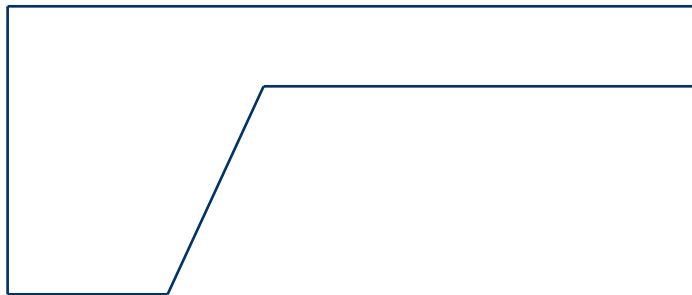

Fig. 1. (a) Dynamic mode. Absorption of analyte molecules in a sensor layer leads to shift in resonance-frequency; (b) static mode: the cantilever bends owing to adsorption of analyte molecules and change of surface stress at the cantilever surface; (c) Scanning electron micrograph of a cantilever array.

## Bulk silicon micromachining

# How to manufacture a beam in single-crystalline silicon

- Silicon wafer:
  - Anisotropic etch of membrane from back side of wafer (e.g. in TMAH)
  - Reactive Ion Etch, through-etch of membrane area around beam.
  - Beam remains, surrounded by hole
  - Beam thickness equals membrane thickness



# Coventor tutorial, aluminum “bridge”

- Surface micromachining
- Aluminum beam on nitride on silicon substrate

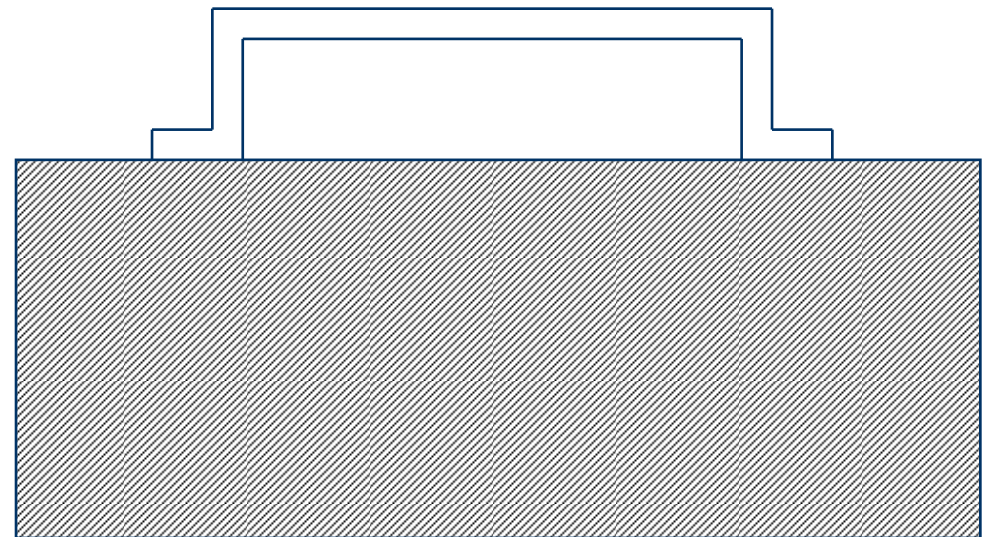
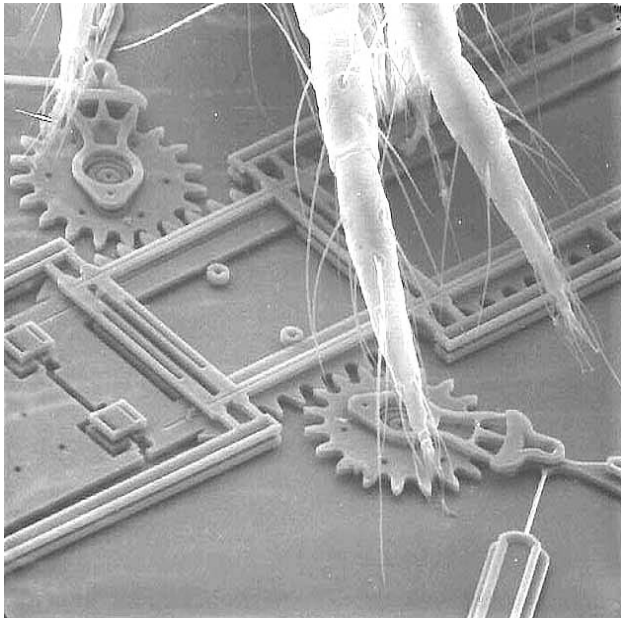

# Why study elasticity?

- Will the mechanical element break due to accelerations and forces?

## Fracture

- During production
- During operation due to environment

- Deflections of sensor and actuator elements due to forces

- Piezoresistive sensors are based on measuring stress/strain in element

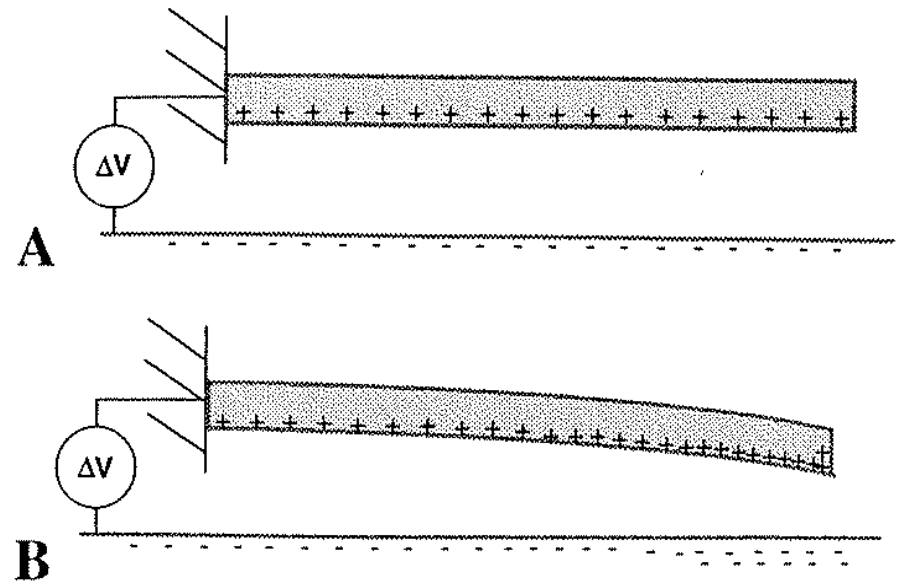



# Sensing principles

- Capacitive, based on displacement
- Piezoresistive, based on mechanical stress-strain

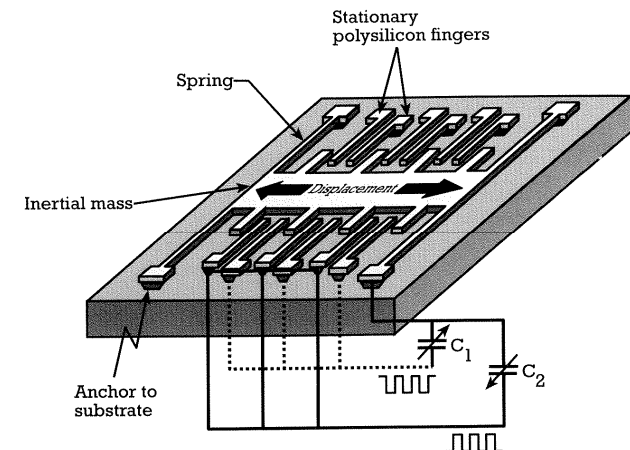
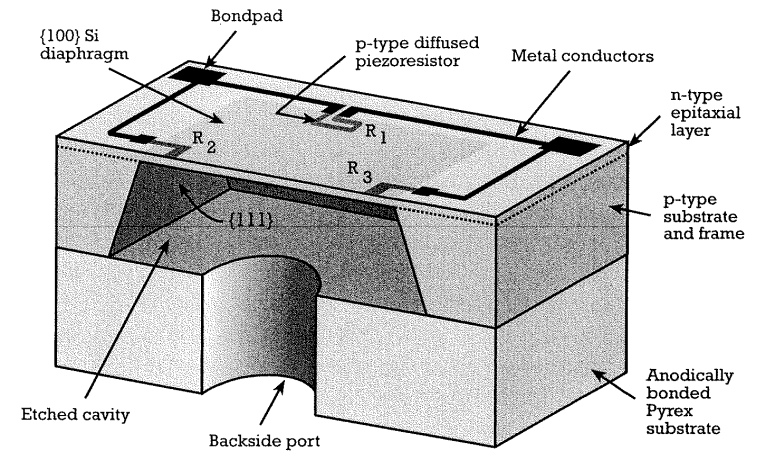

# Stress

- Stress (= mekanisk spenning)
- Stress = force divided by area  
(as area shrinks to zero)
- Stress is a vector acting on a surface
- Direction of both force and surface given
- Stress is the convenient mathematical description of internal forces in a medium
- Stress has multiple values at a point in space, it varies with the orientation of a surface on which the stress acts

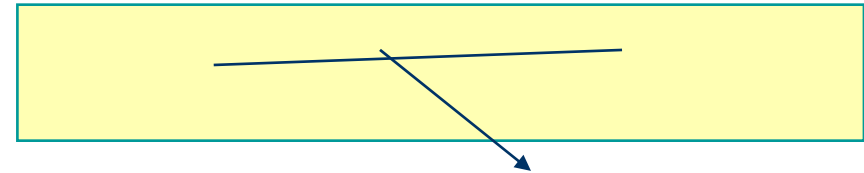



# Hooke's law, elasticity constants

- Consider elongation of a bar
- Hooke's law simplifies in this case to

$$\sigma_{xx} = E\varepsilon_{xx}$$

and

$$\varepsilon_{yy} = -\nu\varepsilon_{xx}$$

$$\varepsilon_{zz} = -\nu\varepsilon_{xx}$$

- $E$ : "spring constant" for change of length
- $\nu$ : measure of relative shrink
- $E$  is normally huge (big force, small elongation)
- $\nu$  is typically 0.3 for metals
- Many alternative elasticity parameters exist: Lamé constants  $\lambda$  and  $\mu$ , shear modulus  $G$  ( $= \mu$ ), bulk modulus  $K$

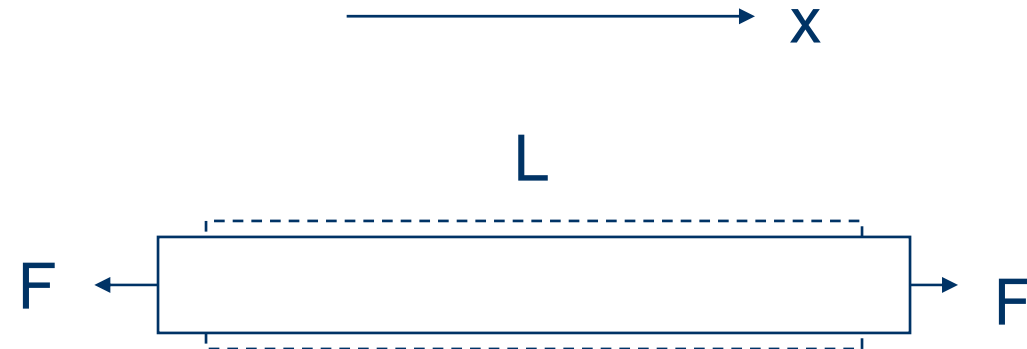

$$\sigma_{xx} = F/A$$

$$\varepsilon_{xx} = \sigma_{xx} / E$$

$$\varepsilon_{xx} = \Delta L / L$$

**E** Youngs modulus,  
elastisitetskonstanten  
 **$\nu$**  poisson ratio

# Material behaviour at large strains

- Linear elastic behaviour for small strains
  - Slope equals Young's modulus
- Brittle materials exhibits linear elasticity until they break

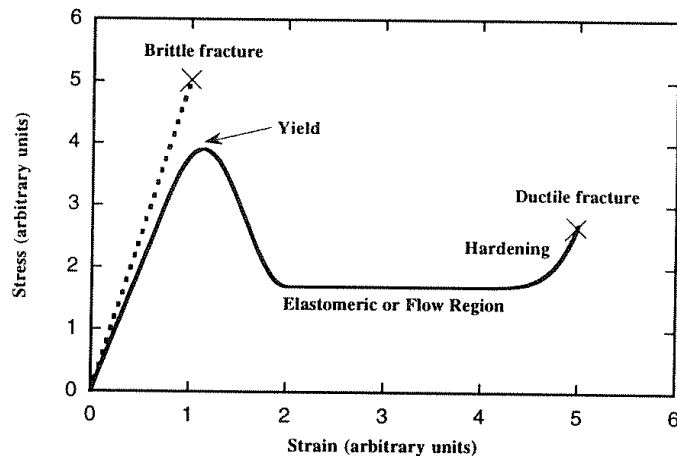
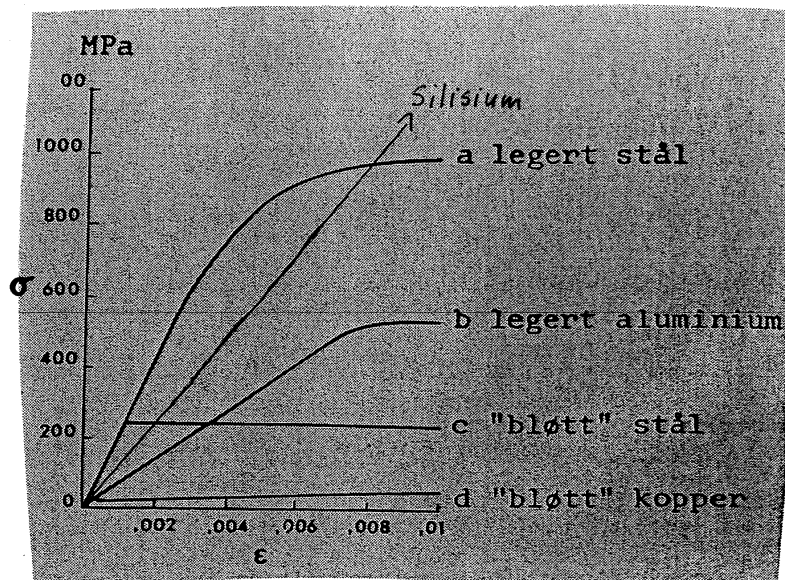

Figure 8.7. Illustrating brittle and ductile materials.

# Silicon as a mechanical material

Fra Irgens: "Fasthetslære"



Spenning/tøyingsdiagram

- Silicon fracture stress: 7000MPa (theoretical value)
- Special for you: SensoNor single crystal silicon: under 500MPa is safe

Desirable mechanical properties:

Linear elastic behaviour until brittle fracture

High fracture stress

Large Young's module (E)

Silicon: Brittle material

# Example: Stress in a bar

## Stress in a bar

Example: consider the stress at the bullet point

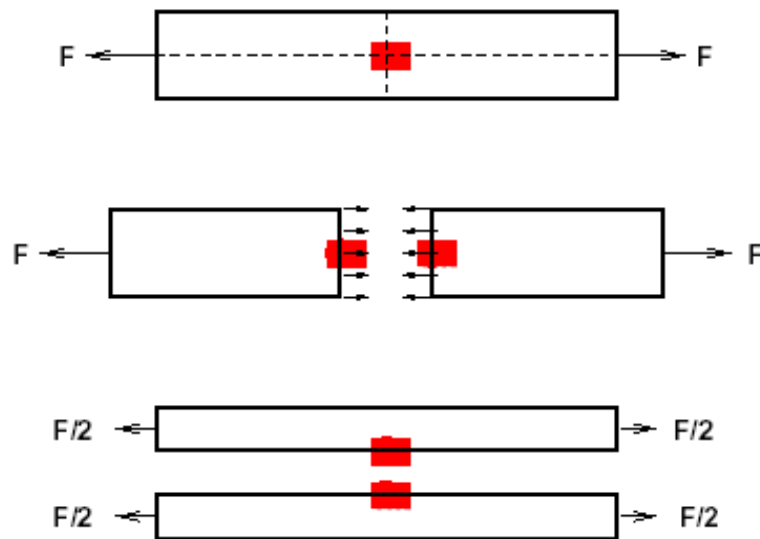

- Simple example: Uniaxial stress
- Two stress values at the same point
- The stress at the bullet point was in one case  $F/A$  ( $F$  - force,  $A$  - area) and in another case 0!
- “Stress” means stress at a point on a surface
- The surface orientation (normal vector  $\underline{n}$ ) is needed for stress vector computations

# The stress tensor

- The quantity  $\boldsymbol{\sigma}$  or  $\sigma_{ij}$  in Cauchy's 1. law is called the stress tensor

- $\boldsymbol{\sigma}$  contains 9 entries:

$$\boldsymbol{\sigma} = \begin{pmatrix} \sigma_{xx} & \sigma_{xy} & \sigma_{xz} \\ \sigma_{yx} & \sigma_{yy} & \sigma_{yz} \\ \sigma_{zx} & \sigma_{zy} & \sigma_{zz} \end{pmatrix}$$

- The interpretation of these entries follows from Cauchy's 1. law:

- $\mathbf{i} \cdot \boldsymbol{\sigma} =$  stress vector on plane  $x = \text{const}$

$$\mathbf{i} \cdot \boldsymbol{\sigma} = \sigma_{xx}\mathbf{i} + \sigma_{xy}\mathbf{j} + \sigma_{xz}\mathbf{k}$$

$\Rightarrow \sigma_{xx}$  is normal stress on a plane  $x = \text{const}$

$\Rightarrow \sigma_{xy}$  is shear stress in  $y$  direction on a plane  $x = \text{const}$

$\Rightarrow \sigma_{xz}$  is shear stress in  $z$  direction on a plane  $x = \text{const}$

## Example: stress in a bar



- Uni-axial tension force

- Cutting the body along coordinate planes

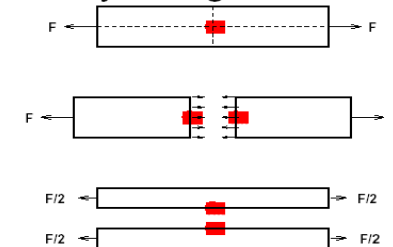

suggests

$$\boldsymbol{\sigma} = \begin{pmatrix} F/A & 0 & 0 \\ 0 & 0 & 0 \\ 0 & 0 & 0 \end{pmatrix}$$

- Remark: physical reasoning indicates such a stress tensor, but only a solution of a full model for elastic deformation can tell if our assumption of  $\boldsymbol{\sigma}$  is correct

# Normal and Shear stresses

## Stress vector computation

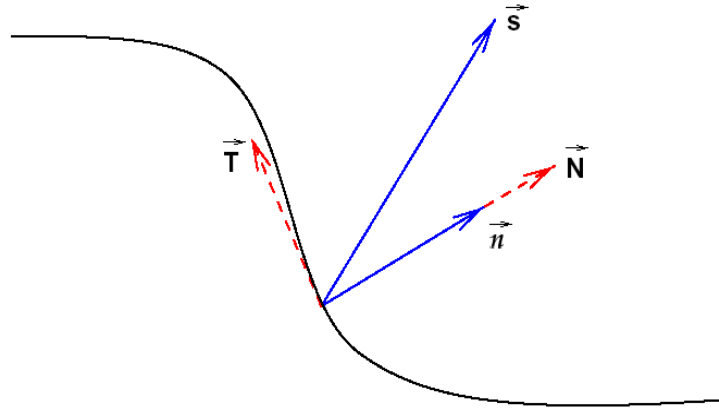

- One often decomposes the stress vector in a normal and a shear part
- Normal stress:  $\sigma_N = \mathbf{s} \cdot \mathbf{n}$
- Normal stress vector:  $\mathbf{N} = \sigma_N \mathbf{n} = (\mathbf{s} \cdot \mathbf{n}) \mathbf{n}$
- Shear stress vector:  $\mathbf{T} = \mathbf{s} - \mathbf{N}$
- Shear stress:  $\sigma_T = \|\mathbf{T}\|$

- The stress vector depends on space, time and the orientation (unit outward normal vector  $\mathbf{n}$ ) of the surface on which the stress vector acts
- Notation:  $\mathbf{s}(\mathbf{x}, t; \mathbf{n})$   
( $\mathbf{s}$  varies with 7 parameters!)
- Cauchy's 1. law makes life simpler:

$$\mathbf{s}(\mathbf{r}, t; \mathbf{n}) = \mathbf{n} \cdot \boldsymbol{\sigma}(\mathbf{x}, t)$$

( $\Rightarrow \mathbf{s}$  has a simple (linear) dependence on  $\mathbf{n}$ )

# Stresses on an infinitesimal cube

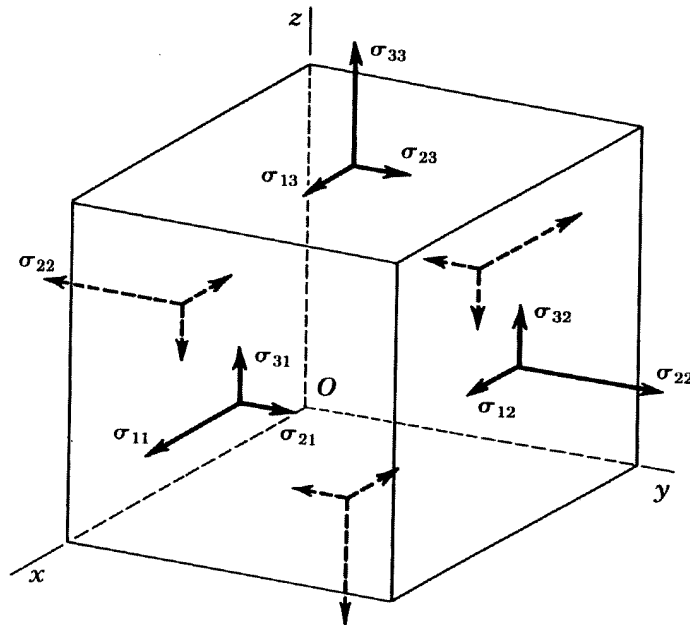

FIGURE 2-1. Stress distribution on an infinitesimal volume element.

- Cube is at rest
- Normal stresses on opposite sides are equal
- No translational motion
- Shear stresses  $\sigma_{21} = \sigma_{12}$
- No rotation



# Stress tensor

## The stress tensor is symmetric

- The stress tensor  $\sigma_{ij}$  is all the information we need to find the stress on an arbitrary surface
- Derivation of Cauchy's 1. law: Study the force equilibrium of a tetrahedron
- Cauchy's 2. law:

$$\sigma_{ij} = \sigma_{ji} \quad (\text{symmetric tensor})$$

derived from moment equilibrium of an arbitrary volume

- With the 2. law, we can rewrite the 1. law:

$$\mathbf{s} = \mathbf{n} \cdot \boldsymbol{\sigma} = \boldsymbol{\sigma} \cdot \mathbf{n}$$

## Alternative stress tensor notation

Instead of writing the stress tensor as a matrix,

$$\boldsymbol{\sigma} = \begin{pmatrix} \sigma_{xx} & \sigma_{xy} & \sigma_{xz} \\ \sigma_{yx} & \sigma_{yy} & \sigma_{yz} \\ \sigma_{zx} & \sigma_{zy} & \sigma_{zz} \end{pmatrix}$$

it is sometimes convenient to collect the six distinct entries in a vector:

$$\begin{pmatrix} \sigma_{xx} \\ \sigma_{yy} \\ \sigma_{zz} \\ \sigma_{xy} \\ \sigma_{yz} \\ \sigma_{zx} \end{pmatrix}$$

# Strain

- Strain is a non-dimensional measure of relative deformations
- Strain is the type of deformation that relates directly to stress
- Deformation = rotation + change of shape
- Pure rotation does not cause internal stress
- Strain is a precise measure of “change of shape”
- Strain is represented by the greek letter  $\varepsilon$
- Strain is a tensor:  $\varepsilon_{ij}$  or  $\boldsymbol{\varepsilon}$

## Examples on strain

- Elongation of a bar:  $\varepsilon = \Delta L/L$
- $\varepsilon$  is here relative change of length
- Generalization to 3D strain:
  - $\varepsilon_{xx}$ : relative change of length in  $x$  dir.
  - $\varepsilon_{yy}$ : relative change of length in  $y$  dir.
  - $\varepsilon_{zz}$ : relative change of length in  $z$  dir.
  - $\varepsilon_{xy}$ : change of the right angle between lines originally in  $x$  and  $y$  direction
  - $\varepsilon_{xz}$ : change of angle
  - $\varepsilon_{yz}$ : change of angle
- The strain tensor is symmetric
- Strain is related to displacement:

$$\varepsilon_{ij} = \frac{1}{2} \left( \frac{\partial u_i}{\partial x_j} + \frac{\partial u_j}{\partial x_i} \right) \quad \text{or} \quad \boldsymbol{\varepsilon} = \frac{1}{2} (\nabla \mathbf{u} + (\nabla \mathbf{u})^T)$$

# Example: Deformation of a square

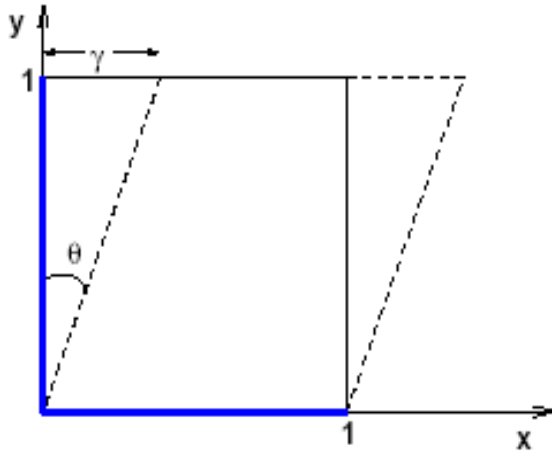

- Deformation:  $\mathbf{u} = \gamma y \mathbf{i}$
- No relative change of lengths of the sides  $\Rightarrow$   
 $\epsilon_{xx} = \epsilon_{yy} = 0$
- Change of angle:  $\gamma \Rightarrow \epsilon_{xy} = \gamma$
- The strain tensor: only  $\epsilon_{xy} = \gamma$  is non-zero

# Example on computing normal/shear stress

- Consider

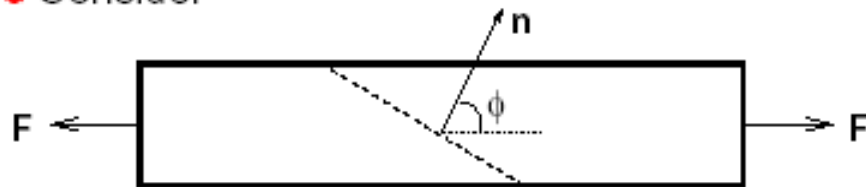

- Stress tensor:

$$\boldsymbol{\sigma} = \begin{pmatrix} F/A & 0 & 0 \\ 0 & 0 & 0 \\ 0 & 0 & 0 \end{pmatrix}$$

- Normal vector on the plane:

$$\mathbf{n} = \cos \phi \mathbf{i} + \sin \phi \mathbf{j}$$

- Stress vector on the plane:

$$\mathbf{s} = \begin{pmatrix} F/A & 0 & 0 \\ 0 & 0 & 0 \\ 0 & 0 & 0 \end{pmatrix} \begin{pmatrix} \cos \phi \\ \sin \phi \\ 0 \end{pmatrix} = \frac{F}{A} \cos \phi \begin{pmatrix} 1 \\ 0 \\ 0 \end{pmatrix}$$

$$\mathbf{s} = \frac{F}{A} \cos \phi \mathbf{i}$$

$$\mathbf{n} = \cos \phi \mathbf{i} + \sin \phi \mathbf{j}$$

- Normal stress:

$$\sigma_N = \mathbf{s} \cdot \mathbf{n} = \frac{F}{A} \cos^2 \phi$$

or with a direction vector:

$$\mathbf{N} = (\mathbf{s} \cdot \mathbf{n}) \mathbf{n} = \frac{F}{A} \cos^2 \phi \mathbf{n}$$

- Shear stress:

$$\mathbf{T} = \mathbf{s} - \mathbf{N} = (F/A) \cos \phi (\sin^2 \phi \mathbf{i} - \cos \phi \sin \phi \mathbf{j}, 0)^T$$

# Basic quantities in elasticity

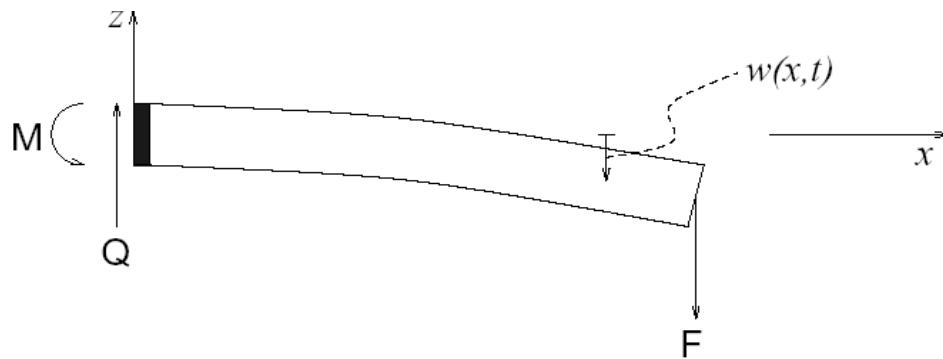

- Primary interest: stress tensor  $\boldsymbol{\sigma}$
- Secondary interest: deformation field  $\boldsymbol{u}$
- Primary unknown in FEM programs: displacement  $\boldsymbol{u}(\boldsymbol{r}, t)$
- First compute displacement, then find stress from simple differentiation
- “Inside” elasticity models we will also meet the concept of strain

## Fundamental quantities

- $\rho(\boldsymbol{x})$ : density
- $\boldsymbol{u}(\boldsymbol{x}, t)$ : displacement (at time  $t$ ) of a point with initial location  $\boldsymbol{x}$
- $\boldsymbol{\sigma}(\boldsymbol{x}, t)$ : stress tensor

# General: Finite Element Analysis

- Solve Navier's equation (partial differential equation)

$$(\lambda + \mu)\nabla(\nabla \cdot \vec{u}) + \mu\nabla^2\vec{u} = 0$$

- Divide domain into elements
- Approximation of function (solution to partial differential equation) over domain
- Simple function over each element (linear, parabolic)
- Connect elements at nodes

Figure T1-20 Viewing the mechanical mesh

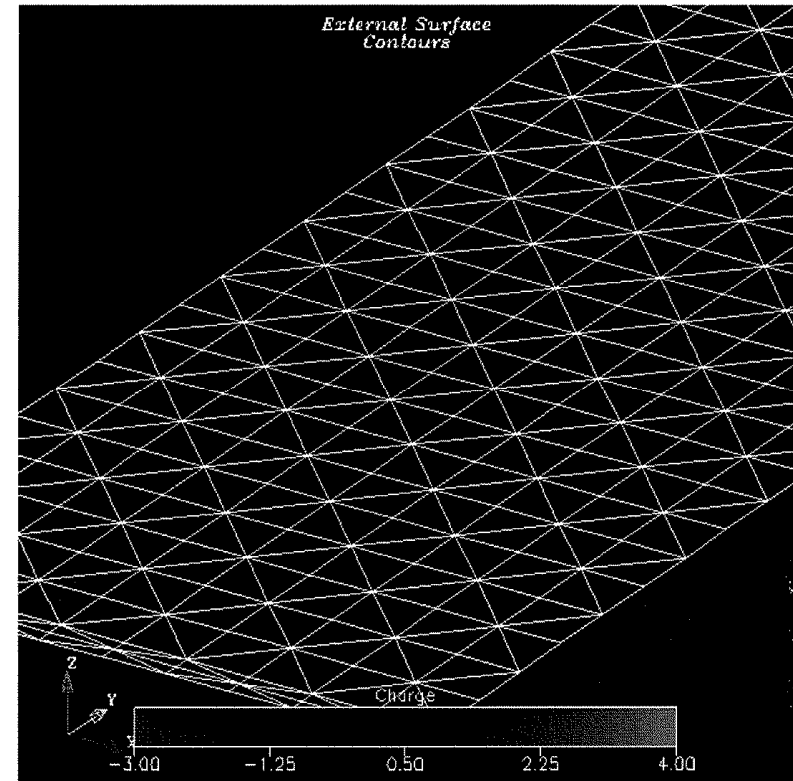



# The mathematical framework of 3D elasticity

- Newton's second law:

$$\rho \frac{\partial^2 \mathbf{u}}{\partial t^2} = \nabla \cdot \boldsymbol{\sigma} + \rho \mathbf{b}$$

( $\mathbf{b}$ : body forces, e.g., external acceleration)

- Hooke's law for an isotropic elastic medium:

$$\begin{pmatrix} \sigma_{xx} \\ \sigma_{yy} \\ \sigma_{zz} \\ \sigma_{xy} \\ \sigma_{yz} \\ \sigma_{zx} \end{pmatrix} = \mathbf{D} \begin{pmatrix} \varepsilon_{xx} \\ \varepsilon_{yy} \\ \varepsilon_{zz} \\ \varepsilon_{xy} \\ \varepsilon_{yz} \\ \varepsilon_{zx} \end{pmatrix}$$

- $\mathbf{D}$ : elasticity coefficients (compliance matrix)
- Strain-displacement relation:

$$\boldsymbol{\varepsilon} = \frac{1}{2}(\nabla \mathbf{u} + (\nabla \mathbf{u})^T)$$

- Can eliminate stress and strain and get a system of partial differential equations for  $\mathbf{u}$ , this is the system that is solved in FEM packages

$$\mathbf{D} = \frac{E(1-\nu)}{(1+\nu)(1-2\nu)} \begin{pmatrix} 1 & \frac{\nu}{1+\nu} & \frac{\nu}{1+\nu} & 0 & 0 & 0 \\ & 1 & \frac{\nu}{1+\nu} & 0 & 0 & 0 \\ & & 1 & 0 & 0 & 0 \\ & & & \frac{1-2\nu}{2(1-\nu)} & 0 & 0 \\ \text{symmetric} & & & & \frac{1-2\nu}{2(1-\nu)} & 0 \\ & & & & & \frac{1-2\nu}{2(1-\nu)} \end{pmatrix}$$

- $E$ : Young's modulus
- $\nu$ : Poisson's ratio

# Relation between stress and strain in a coordinate system with axes equivalent to the axes of the unit cell, cubic crystal

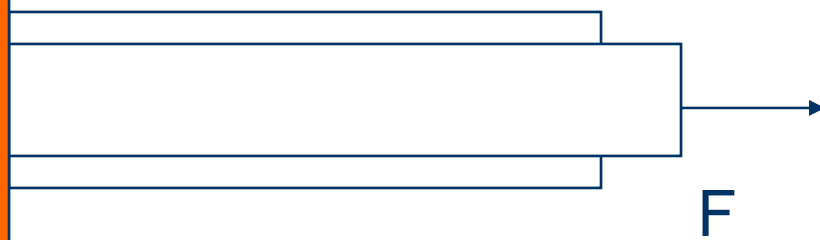

$$\begin{bmatrix} \sigma_x \\ \sigma_y \\ \sigma_z \\ \tau_{yx} \\ \tau_{zx} \\ \tau_{xy} \end{bmatrix} = \begin{bmatrix} C_{11} & C_{12} & C_{12} & 0 & 0 & 0 \\ C_{12} & C_{11} & C_{12} & 0 & 0 & 0 \\ C_{12} & C_{12} & C_{11} & 0 & 0 & 0 \\ 0 & 0 & 0 & C_{44} & 0 & 0 \\ 0 & 0 & 0 & 0 & C_{44} & 0 \\ 0 & 0 & 0 & 0 & 0 & C_{44} \end{bmatrix} \begin{bmatrix} \varepsilon_x \\ \varepsilon_y \\ \varepsilon_z \\ \gamma_{yz} \\ \gamma_{zx} \\ \gamma_{xy} \end{bmatrix}$$

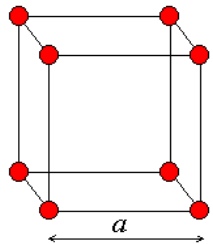

(a)

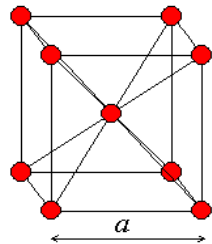

(b)

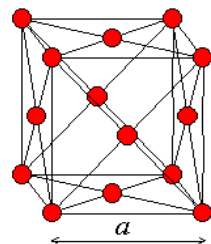

(c)

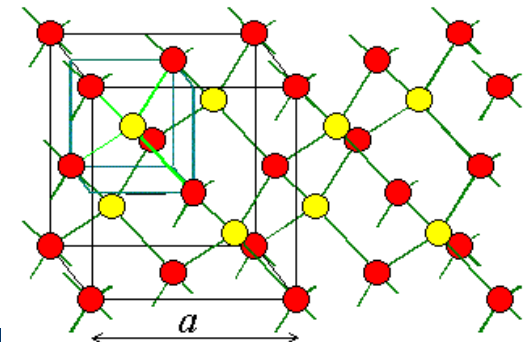
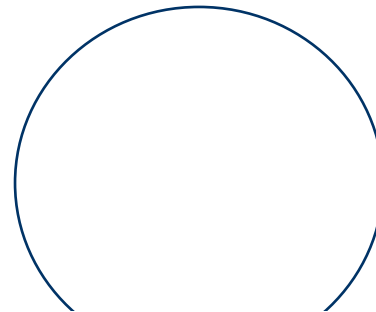

# Elastic constants

Table 8.1. Mechanical property data for selected microelectronic materials. (Sources: [52, 54, 55, 56])

Material	$\rho_m$ kg/m <sup>3</sup>	$E$ GPa	$\nu$	$\alpha_T$ $\mu\text{strain/K}$	$\sigma_o$ MPa	Comment
Silicon	2331	page 193		2.8		Cubic
$\alpha$ -Quartz	2648	page 573		7.4, 13.6		Hexagonal
Quartz (fused)	2196	72	.16	0.5		Amorphous
Polysilicon	2331	160	$\sim 0.2$	2.8	Varies	Random grains
Silicon dioxide	2200	69	.17	0.7	-300	Thermal
Silicon nitride	3170	270	.27	2.3	+1100	Stoichiometric
	3000	270	.27	2.3	-50 – +800	Silicon rich
Aluminum	2697	70	$\sim .3$	23.1	varies	Polycrystalline

- Silicon is anisotropic
  - Cubic crystal
- Need three independent elastic constants

$$\mathbf{C} = \begin{pmatrix} C_{11} & C_{12} & C_{12} & 0 & 0 & 0 \\ C_{12} & C_{11} & C_{12} & 0 & 0 & 0 \\ C_{12} & C_{12} & C_{11} & 0 & 0 & 0 \\ 0 & 0 & 0 & C_{44} & 0 & 0 \\ 0 & 0 & 0 & 0 & C_{44} & 0 \\ 0 & 0 & 0 & 0 & 0 & C_{44} \end{pmatrix} \quad (8.28)$$

where

$$\begin{aligned} C_{11} &= 166 \text{ GPa} \\ C_{12} &= 64 \text{ GPa} \\ C_{44} &= 80 \text{ GPa} \end{aligned}$$

# Silicon anisotropic elasticity constants

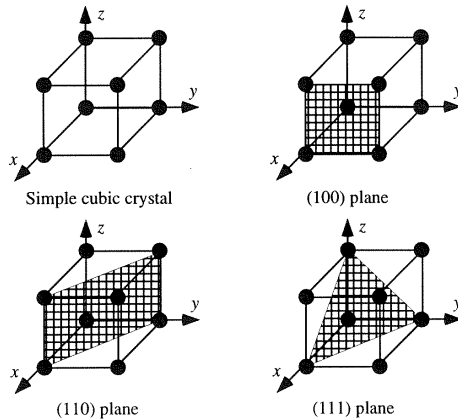

re 3.1. Illustrating the different major crystal planes for a simple cubic lattice of atoms.

- Silicon elasticity constants for crystal directions:
- $E[100]=129\text{GPa}$
- $E[110]=168\text{GPa}$
- $E[111]=186\text{GPa}$

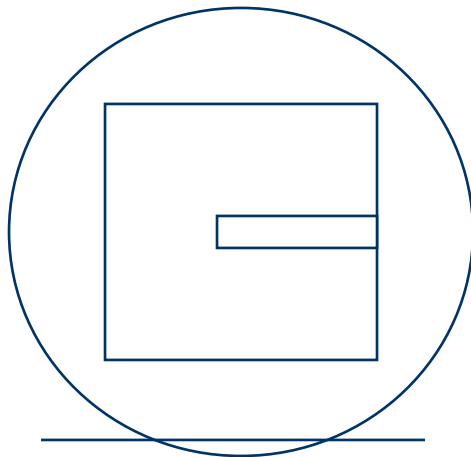

# Beam model

- The mathematics is based on pure bending
- The models are successfully applied far beyond the mathematical assumptions
- Only a 1D Hooke's law is needed ( $\sigma_{xx} = E\varepsilon_{xx}$ ) so isotropy is not an assumption
- The model consists of a differential equation for the deflection of the beam



# Remarks to beam equation

- Although we allow for shear ( $Q$ ),  $\sigma_{xx}$  is the only stress component used in the derivation...
- The  $x$  axis must coincide with the neutral line (line with no strain)
- The neutral line goes through the centroid of the cross section (easy to compute)
- $w(x, t)$  is the deflection from the neutral line, positive downwards in our derivations
- In the derivation of the beam equations, we assume the stress tensor is like the one in uni-axial elongation:

$$\boldsymbol{\sigma} = \begin{pmatrix} Cz & 0 & 0 \\ 0 & 0 & 0 \\ 0 & 0 & 0 \end{pmatrix}, \quad C = \text{const}$$

# Types of support and loads of beams

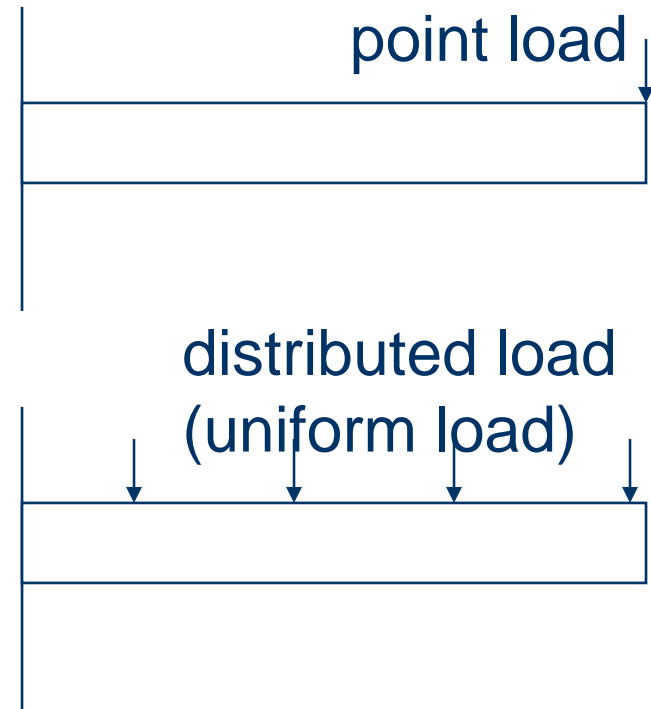
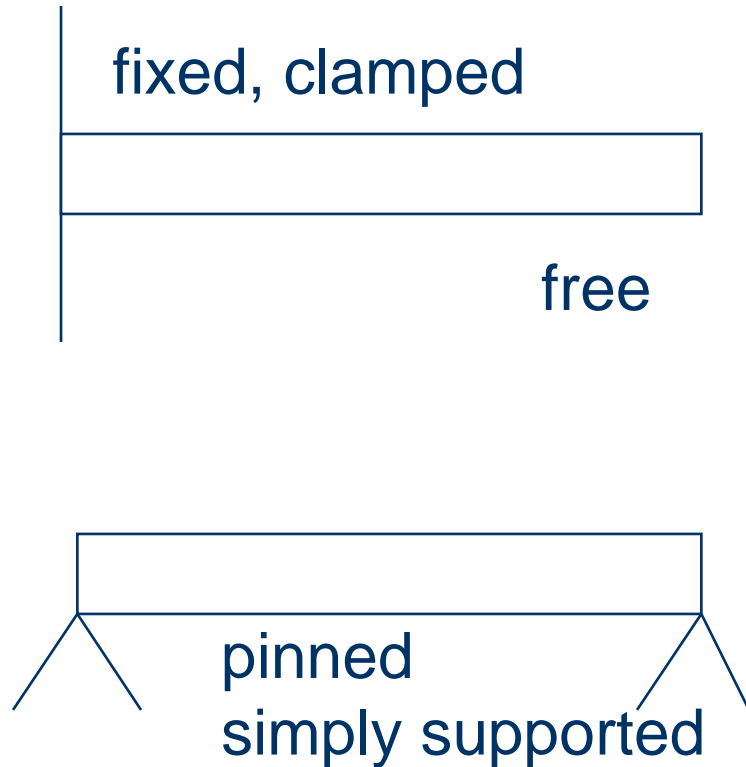



# Example: beam with end load

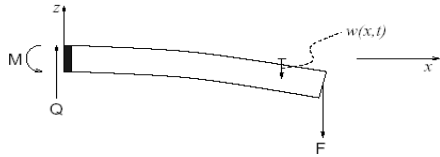

- Assumption: constant rectangular cross section, width  $a$  and height  $b$
- By integration or from tables:  $I = ab^3/12$
- Loads:  $q = 0$ , end load  $D$  prescribed
- Governing equation:

$$EI \frac{d^4 w}{dx^4} = 0$$

- Clamped left end  $x = 0$ :  $w(0) = w'(0) = 0$
- Right end with load:  $EI w'''(L) = F$ ,  $s'' = 0$
- Integrate differential equation four times:

$$w(x) = C_1 x^3 + C_2 x^2 + C_3 x + C_4$$

- Determine  $C_1, \dots, C_4$  from end conditions:

$$w(x) = \frac{FL^3}{6EI} \left(\frac{x}{L}\right)^2 (3 - x/L)$$

$$w(x) = \frac{FL^3}{6EI} \left(\frac{x}{L}\right)^2 (3 - x/L)$$

- Moment:

$$M(x) = F(L - x)$$

- Shear force (constant here):

$$Q(x) = F$$

- Normal stress in a cross section:

$$\sigma_{xx} = z \frac{F}{I} (L - x)$$

- Largest stress at  $x = 0$  and for  $z = \pm b/2$